

Comparators

Ground Sense Comparators

LM393xxx LM339xxx LM2903xxx LM2901xxx

General Description

LM393xxx and LM2903xxx series are two-channel ground sense comparator. LM339xxx and LM2901xxx series are quad. These have features of wide operating voltage that ranges from 3V to 32V with low supply current. These products are suitable for various applications.

Features

- Wide Operating Supply Voltage
- Ground-sensed Input and Output
- Open Collector Output
- Wide Operating Temperature
- Low Offset Voltage

Application

- General Purpose
- Current Monitor
- Battery Monitor
- Multivibrators

Key Specifications

- Operating Supply Voltage Range
 - Single Supply +3.0V to +32.0V
 - Dual Supply ±1.5V to ±16.0V
 - Operating Temperature Range:
 - LM393xxx^{*1}: -40°C to +85°C
 - LM339xxx^{*1}: -40°C to +85°C
 - LM2903xxx^{*2}: -40°C to +125°C
 - LM2901xxx^{*2}: -40°C to +125°C
- ^{*1} Last Time Buy.
^{*2} Partial Last Time Buy.

- Input Offset Voltage 4.5mV (Max)

Packages

	W(Typ) x D(Typ) x H(Max)
SOP8 ^{*1}	5.00mm x 6.20mm x 1.71mm
SOP-J8 ^{*2}	4.90mm x 6.00mm x 1.65mm
SSOP-B8 ^{*1}	3.00mm x 6.40mm x 1.35mm
TSSOP-B8 ^{*2}	3.00mm x 6.40mm x 1.20mm
TSSOP-B8J ^{*1}	3.00mm x 4.90mm x 1.10mm
MSOP8 ^{*2}	2.90mm x 4.00mm x 0.90mm
SOP14 ^{*2}	8.70mm x 6.20mm x 1.71mm
SOP-J14 ^{*1}	8.65mm x 6.00mm x 1.65mm
SSOP-B14 ^{*2}	5.00mm x 6.40mm x 1.35mm
TSSOP-B14J ^{*1}	5.00mm x 6.40mm x 1.20mm

^{*1} Last Time Buy.
^{*2} Partial Last Time Buy.

Pin Configuration

- LM393F^{*1}, LM2903F^{*1} : SOP8
 - LM393FJ^{*1}, LM2903FJ : SOP-J8
 - LM393FV^{*1}, LM2903FV^{*1} : SSOP-B8
 - LM393FVT^{*1}, LM2903FVT : TSSOP-B8
 - LM393FVJ^{*1}, LM2903FVJ^{*1} : TSSOP-B8J
 - LM393FVM^{*1}, LM2903FVM : MSOP8
- ^{*1} Last Time Buy.

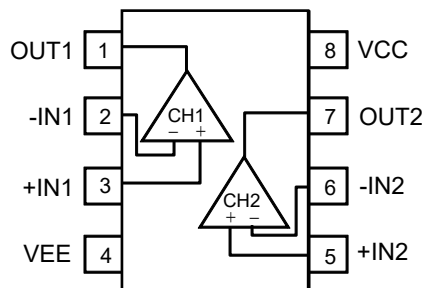

Pin No.	Pin Name
1	OUT1
2	-IN1
3	+IN1
4	VEE
5	+IN2
6	-IN2
7	OUT2
8	VCC

○Product structure : Silicon integrated circuit ○This product has no designed protection against radioactive rays.

Pin Configuration – continued

LM339F^{*1}, LM2901F : SOP-14
 LM339FJ^{*1}, LM2901FJ^{*1} : SOP-J14
 LM339FV^{*1}, LM2901FV : SSOP-B14
 LM339FVJ^{*1}, LM2901FVJ^{*1} : TSSOP-B14J

^{*1}Last Time Buy.

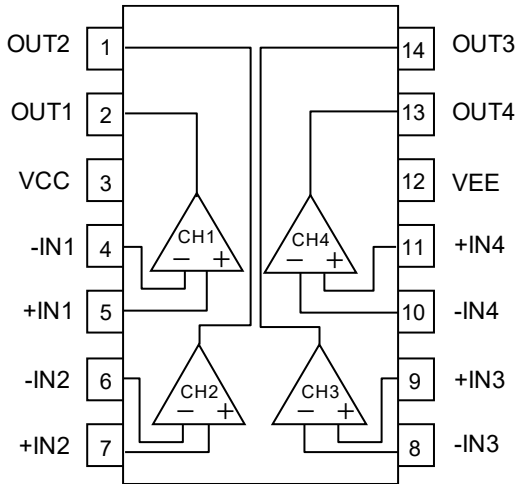

Pin No.	Pin Name
1	OUT2
2	OUT1
3	VCC
4	-IN1
5	+IN1
6	-IN2
7	+IN2
8	-IN3
9	+IN3
10	-IN4
11	+IN4
12	VEE
13	OUT4
14	OUT3

Absolute Maximum Ratings (T_A=25°C)

Parameter	Symbol	Rating				Unit		
		LM393xxx ^{*1}	LM339xxx ^{*1}	LM2903xxx ^{*2}	LM2901xxx ^{*2}			
Supply Voltage	V _{CC} -V _{EE}	+36				V		
Power Dissipation	P _D	SOP8 ^{*1}	0.68 ^(Note 1,9)	-	0.68 ^(Note 1,9)	-	W	
		SOP-J8 ^{*2}	0.67 ^(Note 2,9)	-	0.67 ^(Note 2,9)	-		
		SSOP-B8 ^{*1}	0.62 ^(Note 3,9)	-	0.62 ^(Note 3,9)	-		
		TSSOP-B8 ^{*2}	0.62 ^(Note 3,9)	-	0.62 ^(Note 3,9)	-		
		TSSOP-B8J ^{*1}	0.58 ^(Note 4,9)	-	0.58 ^(Note 4,9)	-		
		MSOP8 ^{*2}	0.58 ^(Note 4,9)	-	0.58 ^(Note 4,9)	-		
		SOP14 ^{*2}	-	0.56 ^(Note 5,9)	-	0.56 ^(Note 5,9)		-
		SOP-J14 ^{*1}	-	1.02 ^(Note 6,9)	-	1.02 ^(Note 6,9)		-
		SSOP-B14 ^{*2}	-	0.87 ^(Note 7,9)	-	0.87 ^(Note 7,9)		-
TSSOP-B14J ^{*1}	-	0.85 ^(Note 8,9)	-	0.85 ^(Note 8,9)	-			
Differential Input Voltage ^(Note 10)	V _{ID}	+36				V		
Common-mode Input Voltage range	V _{ICM}	(V _{EE} -0.3) to (V _{EE} +36)				V		
Input Current ^(Note 11)	I _I	-10				mA		
Operating Supply Voltage	V _{opr}	Single Supply	+3.0 to +32.0			V		
		Dual Supply	±1.5 to ±16.0					
Operating Temperature Range	T _{opr}	-40 to +85		-40 to +125		°C		
Storage Temperature Range	T _{stg}	-55 to +150				°C		
Maximum Junction Temperature	T _{jmax}	+150				°C		

^{*1}Last Time Buy.

^{*2}Partial Last Time Buy.

(Note 1) Reduce 5.5mW per 1°C above 25°C.

(Note 2) Reduce 5.4mW per 1°C above 25°C.

(Note 3) Reduce 5.0mW per 1°C above 25°C.

(Note 4) Reduce 4.7mW per 1°C above 25°C.

(Note 5) Reduce 4.5mW per 1°C above 25°C.

(Note 6) Reduce 8.2mW per 1°C above 25°C.

(Note 7) Reduce 7.0mW per 1°C above 25°C.

(Note 8) Reduce 6.8mW per 1°C above 25°C.

(Note 9) Mounted on an FR4 glass epoxy PCB 70mm×70mm×1.6mm (Copper foil area less than 3%).

(Note 10) Differential Input Voltage is the voltage difference between the inverting and non-inverting inputs. The input pin voltage is set to more than V_{EE}.

(Note 11) An excessive input current will flow when input voltages of less than V_{EE}-0.6V are applied.

The input current can be set to less than the rated current by adding a limiting resistor.

Caution: Operating the IC over the absolute maximum ratings may damage the IC. The damage can either be a short circuit between pins or an open circuit between pins and the internal circuitry. Therefore, it is important to consider circuit protection measures, such as adding a fuse, in case the IC is operated over the absolute maximum ratings.

Electrical Characteristics

OLM393xxx^{*1}, LM2903xxx^{*2} (Unless otherwise specified V_{CC}=+5V, V_{EE}=0V, T_A=25°C)

Parameter	Symbol	Temperature Range	Limit			Unit	Condition
			Min	Typ	Max		
Input Offset Voltage ^(Note 12,13)	V _{IO}	25°C	-	1	4.5	mV	V _{OUT} =1.4V
		Full range	-	-	5		V _{CC} =5 to 32V, V _{OUT} =1.4V
Input Offset Current ^(Note 12,13)	I _{IO}	25°C	-	5	50	nA	V _{OUT} =1.4V
		Full range	-	-	200		
Input Bias Current ^(Note 12,13)	I _B	25°C	-	50	250	nA	V _{OUT} =1.4V
		Full range	-	-	500		
Input Common-mode Voltage Range	V _{ICM}	25°C	0	-	V _{CC} -1.5	V	-
Large Signal Voltage Gain	A _V	25°C	31	1000	-	V/mV	V _{CC} =15V, V _{OUT} =1.4 to 11.4V, R _L =15kΩ, V _{RL} =15V
			90	120	-		
Supply Current ^(Note 13)	I _{CC}	25°C	-	0.6	1	mA	V _{OUT} =Open
		Full range	-	-	1.5		V _{OUT} =Open, V _{CC} =32V
Output Sink Current ^(Note 14)	I _{SINK}	25°C	8	16	-	mA	V _{+IN} =0V, V _{-IN} =1V, V _{OUT} =1.5V
Output Saturation Voltage ^(Note 13) (Low Level Output Voltage)	V _{OL}	25°C	-	80	200	mV	V _{+IN} =0V, V _{-IN} =1V I _{SINK} =4mA
		Full range	-	-	400		
Output Leakage Current ^(Note 13) (High Level Output Current)	I _{LEAK}	25°C	-	0.1	-	nA	V _{+IN} =1V, V _{-IN} =0V, V _{OUT} =5V
		Full range	-	-	1		μA
Response Time	t _{RE}	25°C	-	1	-	μs	R _L =5.1kΩ, V _{RL} =5V, V _{IN} =100mV _{P-P} , Overdrive=5mV
			-	0.4	-		R _L =5.1kΩ, V _{RL} =5V, V _{IN} =TTL, Logic Swing, V _{REF} =1.4V

*1 Last Time Buy.

*2 Partial Last Time Buy.

(Note 12) Absolute value

(Note 13) LM393xxx Full range: T_A=-40°C to +85°C, LM2903xxx Full range: T_A=-40°C to +125°C.

(Note 14) Consider the power dissipation of the IC under high temperature when selecting the output current value.

There may be a case where the output current value is reduced due to the rise in IC temperature caused by the heat generated inside the IC.

Electrical Characteristics - continued

OLM339xxx^{*1}, LM2901xxx^{*2} (Unless otherwise specified V_{CC}=+5V, V_{EE}=0V, T_A=25°C)

Parameter	Symbol	Temperature Range	Limit			Unit	Condition
			Min	Typ	Max		
Input Offset Voltage ^(Note 15,16)	V _{IO}	25°C	-	1	4.5	mV	V _{OUT} =1.4V
		Full range	-	-	5		V _{CC} =5 to 32V, V _{OUT} =1.4V
Input Offset Current ^(Note 15,16)	I _{IO}	25°C	-	5	50	nA	V _{OUT} =1.4V
		Full range	-	-	200		
Input Bias Current ^(Note 15,16)	I _B	25°C	-	50	250	nA	V _{OUT} =1.4V
		Full range	-	-	500		
Input Common-mode Voltage Range	V _{ICM}	25°C	0	-	V _{CC} -1.5	V	-
Large Signal Voltage Gain	A _V	25°C	31	1000	-	V/mV	V _{CC} =15V, V _{OUT} =1.4 to 11.4V, R _L =15kΩ, V _{RL} =15V
			90	120	-	dB	
Supply Current ^(Note 16)	I _{CC}	25°C	-	1.2	2	mA	V _{OUT} =Open
		Full range	-	-	2.5		V _{OUT} =Open, V _{CC} =32V
Output Sink Current ^(Note 17)	I _{SINK}	25°C	8	16	-	mA	V _{+IN} =0V, V _{-IN} =1V, V _{OUT} =1.5V
Output Saturation Voltage ^(Note 16) (Low Level Output Voltage)	V _{OL}	25°C	-	80	200	mV	V _{+IN} =0V, V _{-IN} =1V I _{SINK} =4mA
		Full range	-	-	400		
Output Leakage Current ^(Note 16) (High Level Output Current)	I _{LEAK}	25°C	-	0.1	-	nA	V _{+IN} =1V, V _{-IN} =0V, V _{OUT} =5V
		Full range	-	-	1	μA	V _{+IN} =1V, V _{-IN} =0V, V _{OUT} =32V
Response Time	t _{RE}	25°C	-	1	-	μs	R _L =5.1kΩ, V _{RL} =5V, V _{IN} =100mV _{P-P} , Overdrive=5mV
			-	0.4	-		R _L =5.1kΩ, V _{RL} =5V, V _{IN} =TTL, Logic Swing, V _{REF} =1.4V

*1 Last Time Buy.

*2 Partial Last Time Buy.

(Note 15) Absolute value

(Note 16) LM339xxx Full range: T_A=-40°C to +85°C, LM2901xxx Full range: T_A=-40°C to +125°C.

(Note 17) Consider the power dissipation of the IC under high temperature when selecting the output current value.

There may be a case where the output current value is reduced due to the rise in IC temperature caused by the heat generated inside the IC.

Description of Electrical Characteristics

The relevant electrical terms used in this datasheet are described below. Items and symbols used are also shown. Note that item names, symbols, and their meanings may differ from those of another manufacturer's document or general document.

1. Absolute Maximum Ratings

Absolute maximum rating items indicate the condition which must not be exceeded. Application of voltage in excess of the absolute maximum rating or use out of absolute maximum rated temperature environment may cause deterioration of electrical characteristics.

- (1) Supply Voltage (V_{CC}/V_{EE})
Indicates the maximum voltage that can be applied between the VCC pin and VEE pin without deterioration of characteristics of internal circuit.
- (2) Differential Input Voltage (V_{ID})
Indicates the maximum voltage that can be applied between the non-inverting and inverting pins without damaging the IC.
- (3) Input Common-mode Voltage Range (V_{ICM})
Indicates the maximum voltage that can be applied to the non-inverting and inverting pins without deterioration or destruction of electrical characteristics. Input common-mode voltage range of the maximum ratings does not assure normal operation of IC. For normal operation, use the IC within the input common-mode voltage range characteristics.
- (4) Power Dissipation (P_D)
Indicates the power that can be consumed by the IC when mounted on a specific board at the ambient temperature 25°C (normal temperature). As for package product, P_D is determined by the temperature that can be permitted by the IC in the package (maximum junction temperature) and the thermal resistance of the package.

2. Electrical Characteristics

- (1) Input Offset Voltage (V_{IO})
Indicates the voltage difference between non-inverting pin and inverting pin. It can be translated to the input voltage difference required for setting the output voltage to 0V.
- (2) Input Offset Current (I_{IO})
Indicates the difference of input bias current between the non-inverting and inverting pins.
- (3) Input Bias Current (I_B)
Indicates the current that flows into or out of the input pin. It is defined by the average of input bias currents at the non-inverting and inverting pins.
- (4) Input Common-mode Voltage Range (V_{ICM})
Indicates the input voltage range at which IC normally operates.
- (5) Large Signal Voltage Gain (A_V)
Indicates the amplification rate (gain) of output voltage against the voltage difference between non-inverting pin and inverting pin. It is normally the amplification rate (gain) with reference to DC voltage.
 $A_V = (\text{Output Voltage}) / (\text{Differential Input Voltage})$
- (6) Supply Current (I_{CC})
Indicates the current that flows within the IC under specified no-load conditions.
- (7) Output Sink Current (I_{SINK})
The maximum current that the IC can output under specific output conditions
- (8) Output Saturation Voltage, Low Level Output Voltage (V_{OL})
Signifies the voltage range that can be output under specific output conditions.
- (9) Output Leakage Current, High Level Output Current (I_{LEAK})
Indicates the current that flows into the IC under specific input and output conditions.
- (10) Response Time (t_{RE})
Response time indicates the delay time between the input and output signal which is determined by the time difference from the fifty percent of input signal swing to the fifty percent of output signal swing.

Typical Performance Curves

OLM393xxx*1, LM2903xxx*2

*1 Last Time Buy.

*2 Partial Last Time Buy.

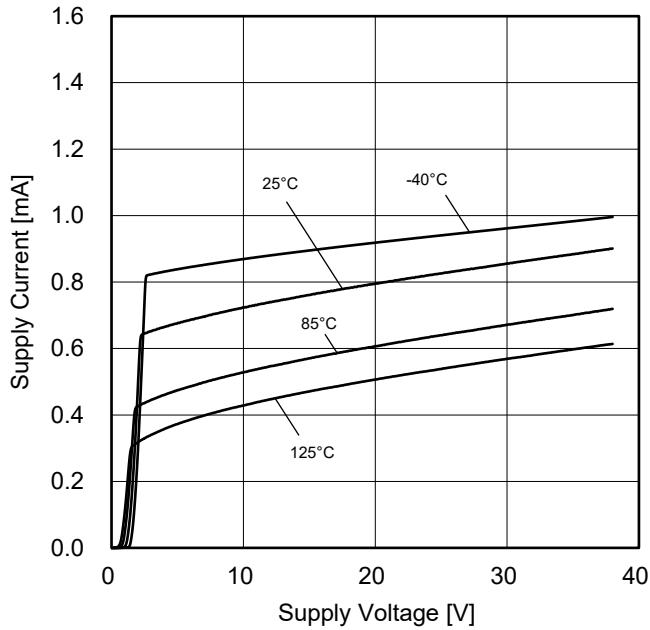

Figure 1. Supply Current vs Supply Voltage

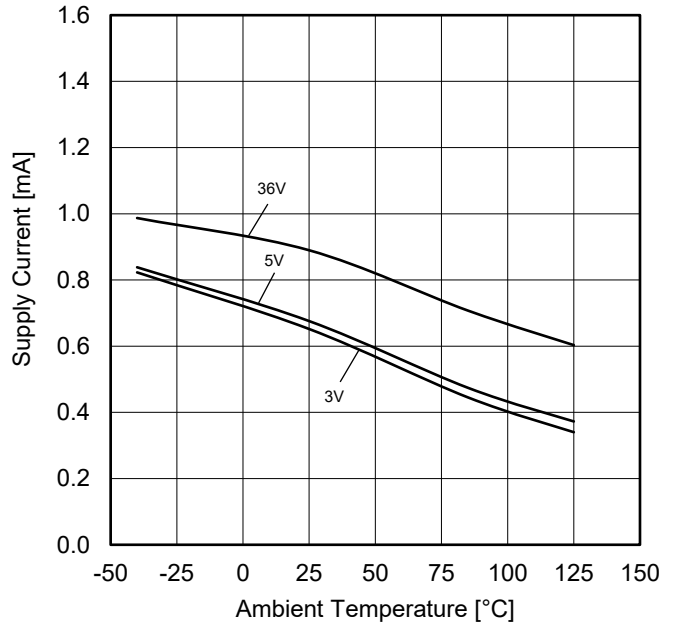

Figure 2. Supply Current vs Ambient Temperature

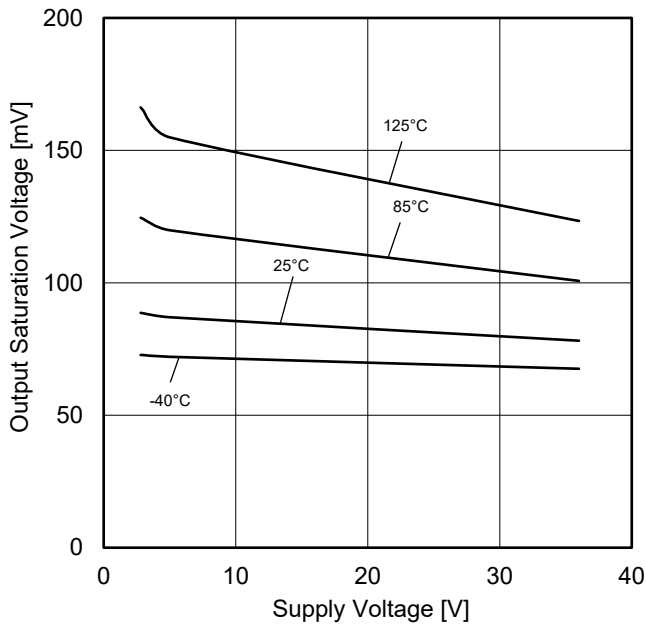

Figure 3. Output Saturation Voltage vs Supply Voltage (I_{SINK}=4mA)

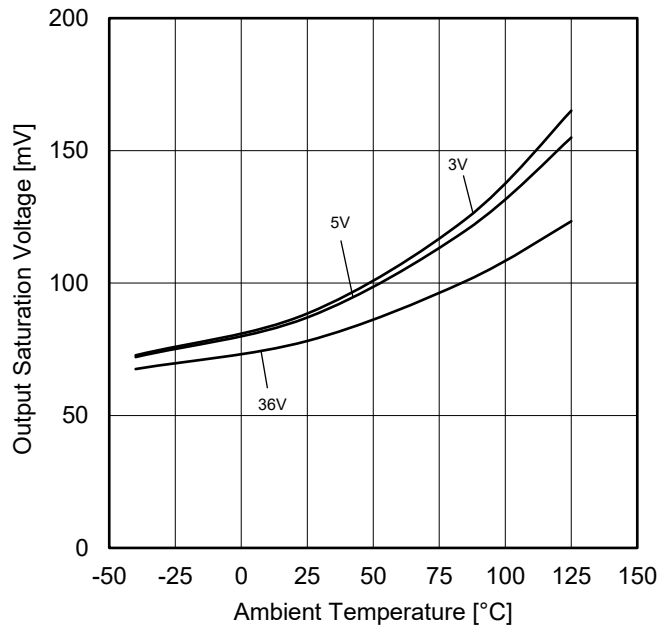

Figure 4. Output Saturation Voltage vs Ambient Temperature (I_{SINK}=4mA)

(*) The above data are measurement values of a typical sample, it is not guaranteed.

LM393xxx: -40°C to +85°C LM2903xxx: -40°C to +125°C

Typical Performance Curves - continued

OLM393xxx^{*1}, LM2903xxx^{*2}

*1 Last Time Buy.

*2 Partial Last Time Buy.

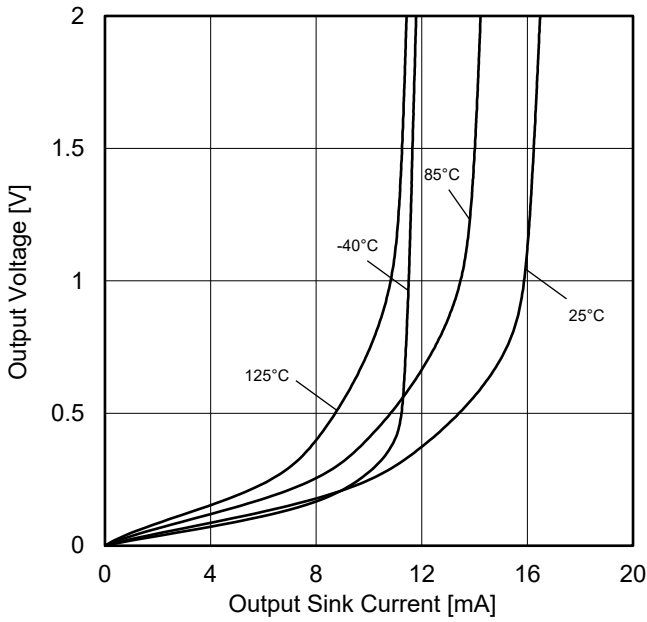

Figure 5. Output Voltage vs Output Sink Current (V_{CC}=5V)

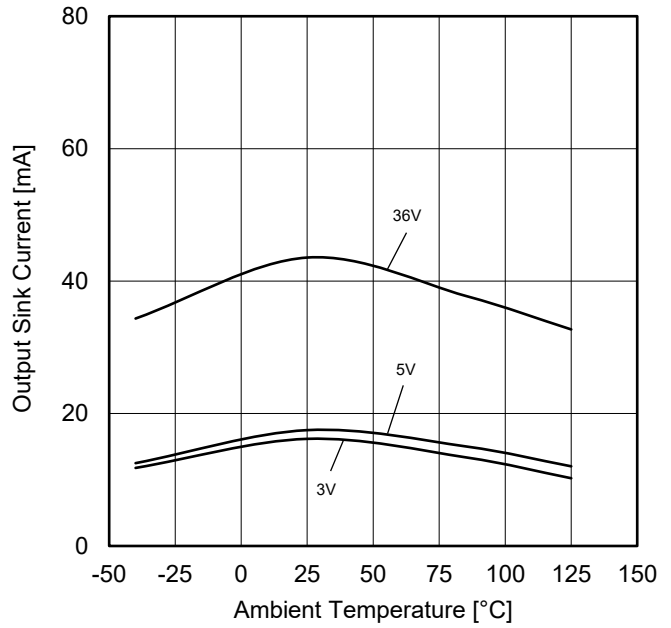

Figure 6. Output Sink Current vs Ambient Temperature (V_{OUT}=V_{CC})

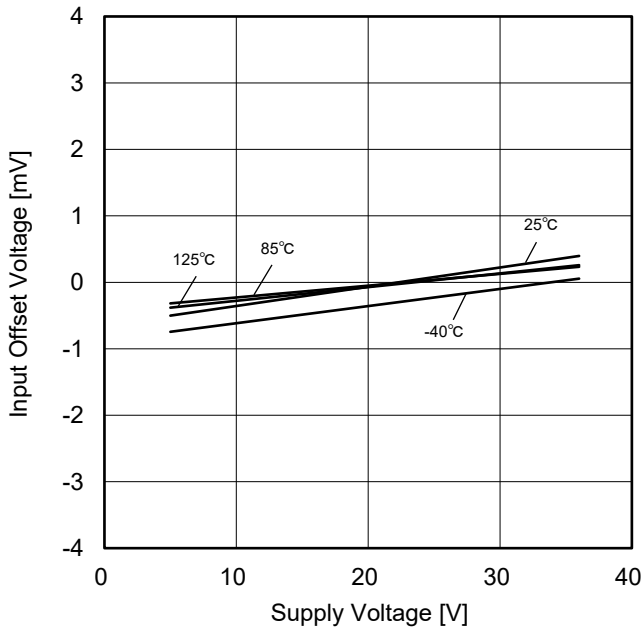

Figure 7. Input Offset Voltage vs Supply Voltage

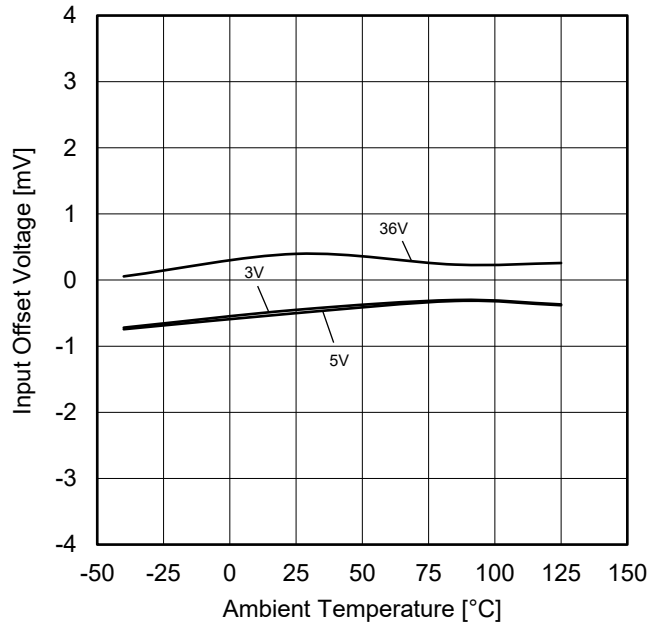

Figure 8. Input Offset Voltage vs Ambient Temperature

(*) The above data are measurement values of a typical sample, it is not guaranteed.

LM393xxx: -40°C to +85°C LM2903xxx: -40°C to +125°C

Typical Performance Curves - continued

OLM393xxx^{*1}, LM2903xxx^{*2}

*1 Last Time Buy.

*2 Partial Last Time Buy.

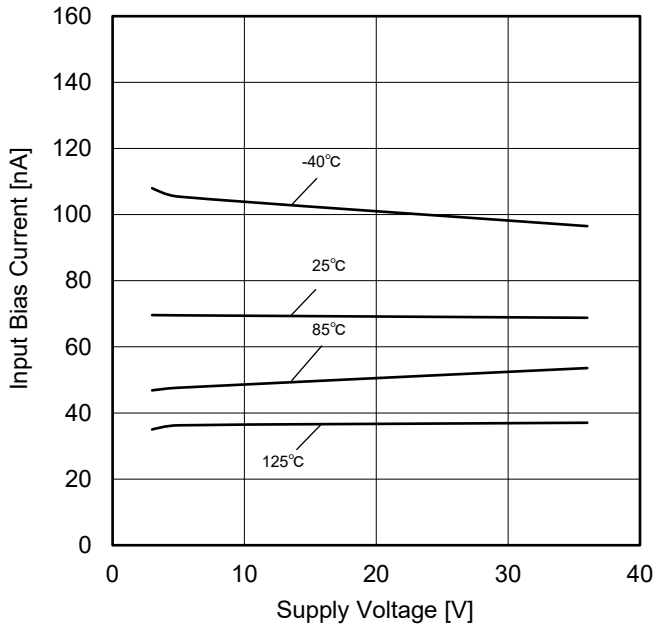

Figure 9. Input Bias Current vs Supply Voltage

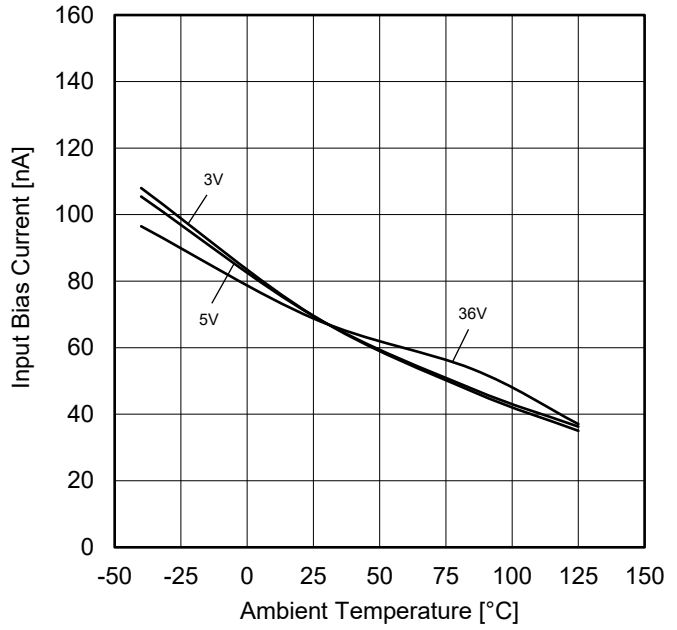

Figure 10. Input Bias Current vs Ambient Temperature

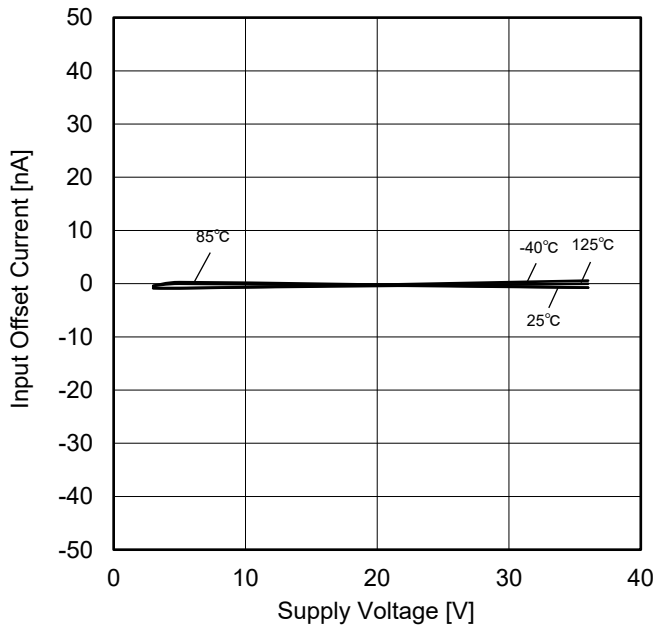

Figure 11. Input Offset Current vs Supply Voltage

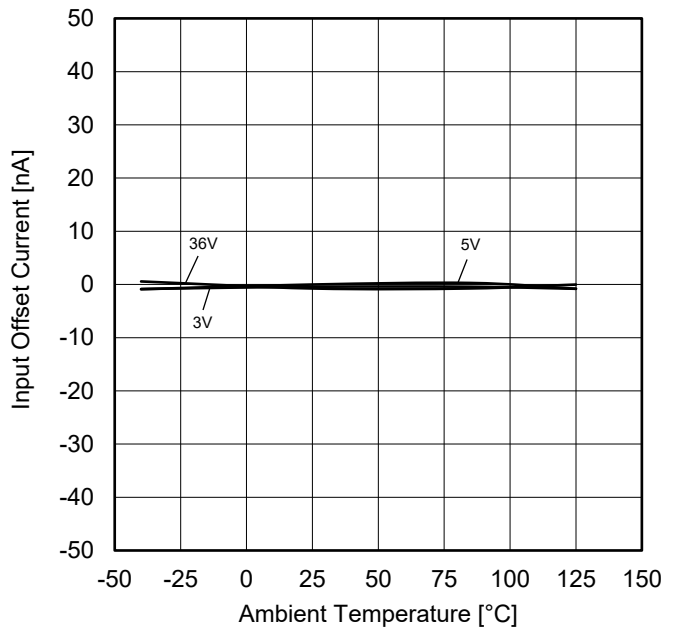

Figure 12. Input Offset Current vs Ambient Temperature

(*) The above data are measurement values of a typical sample, it is not guaranteed.

LM393xxx: -40°C to +85°C LM2903xxx: -40°C to +125°C

Typical Performance Curves - continued

OLM393xxx^{*1}, LM2903xxx^{*2}

^{*1}Last Time Buy.

^{*2}Partial Last Time Buy.

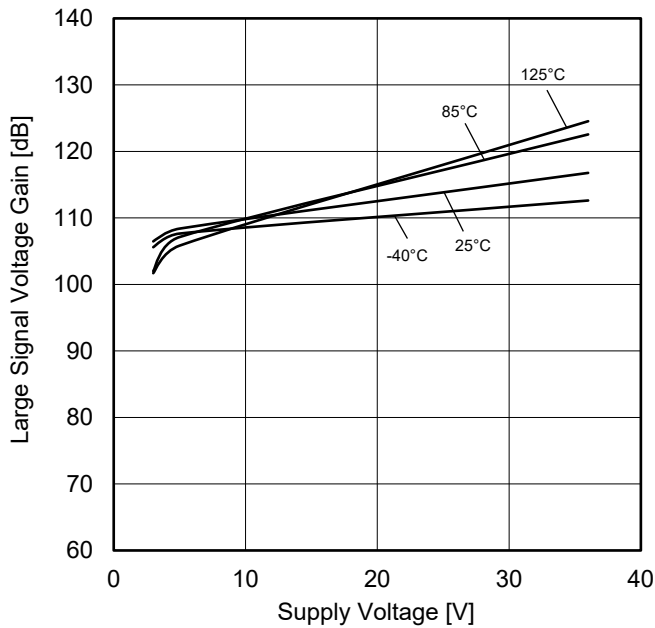

Figure 13. Large Signal Voltage Gain vs Supply Voltage ($R_L=15k\Omega$)

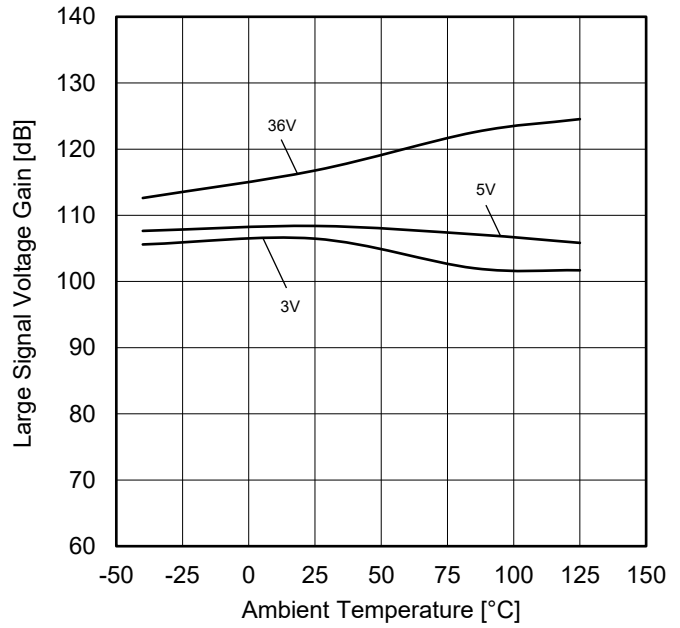

Figure 14. Large Signal Voltage Gain vs Ambient Temperature ($R_L=15k\Omega$)

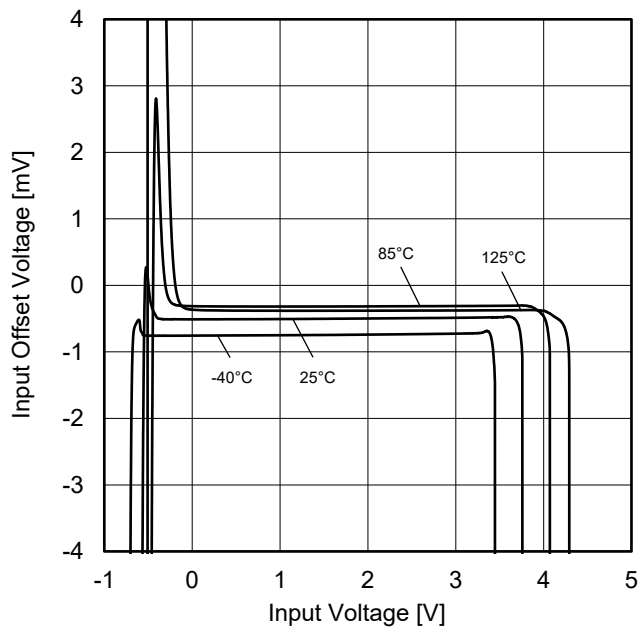

Figure 15. Input Offset Voltage vs Input Voltage ($V_{CC}=5V$)

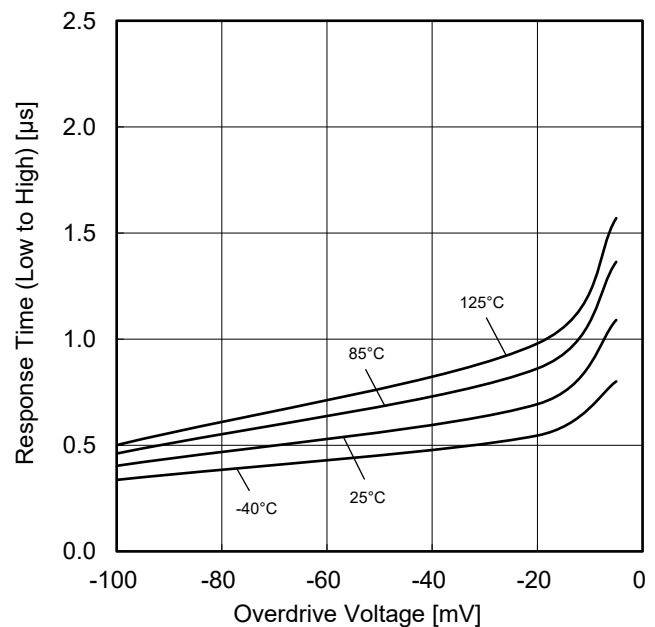

Figure 16. Response Time (Low to High) vs Overdrive Voltage ($V_{CC}=5V, V_{RL}=5V, R_L=5.1k\Omega$)

(*) The above data are measurement values of a typical sample, it is not guaranteed.

LM393xxx: -40°C to +85°C LM2903xxx: -40°C to +125°C

Typical Performance Curves - continued

OLM393xxx^{*1}, LM2903xxx^{*2}

^{*1}Last Time Buy.

^{*2}Partial Last Time Buy.

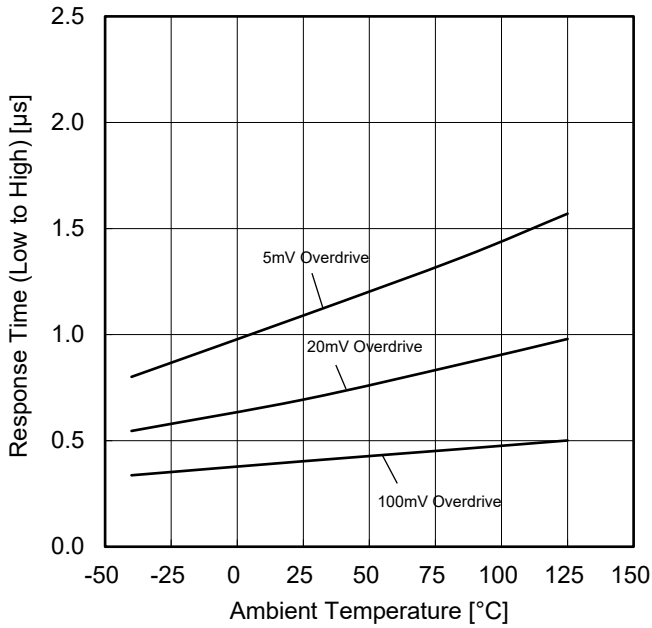

Figure 17. Response Time (Low to High) vs Ambient Temperature ($V_{CC}=5V$, $V_{RL}=5V$, $R_L=5.1k\Omega$)

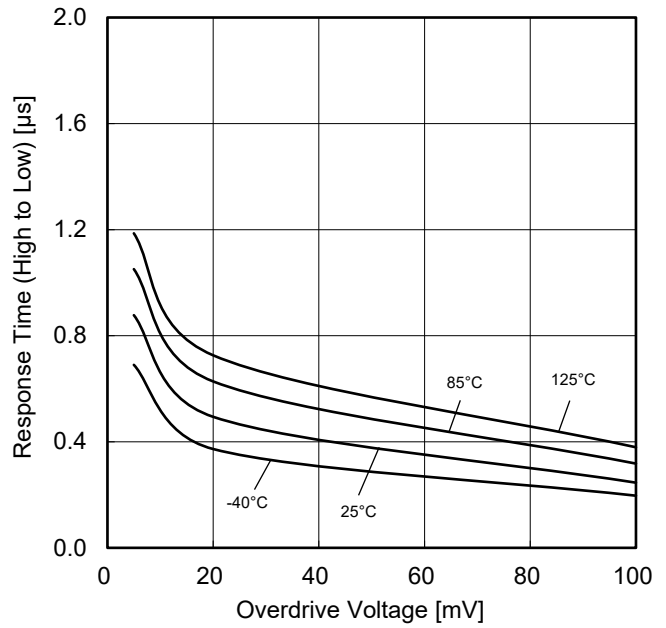

Figure 18. Response Time (High to Low) vs Overdrive Voltage ($V_{CC}=5V$, $V_{RL}=5V$, $R_L=5.1k\Omega$)

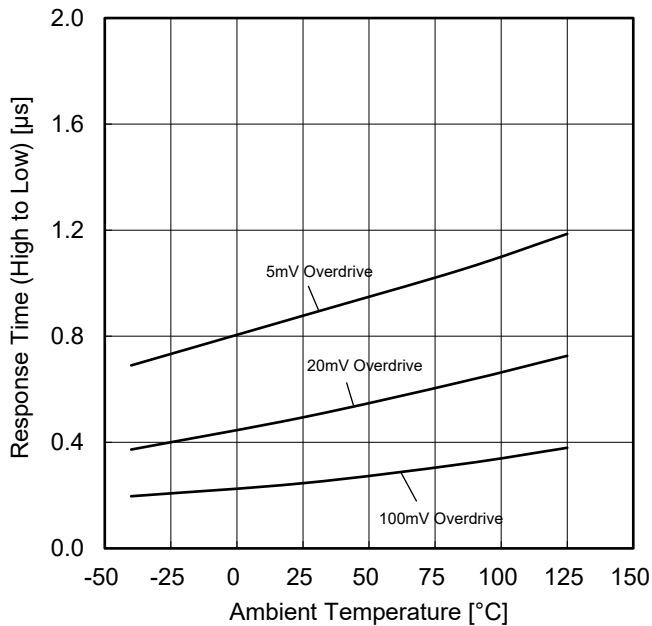

Figure 19. Response Time (High to Low) vs Ambient Temperature ($V_{CC}=5V$, $V_{RL}=5V$, $R_L=5.1k\Omega$)

(*) The above data are measurement values of a typical sample, it is not guaranteed.
 LM393xxx: -40°C to +85°C LM2903xxx: -40°C to +125°C

Typical Performance Curves - continued

OLM339xxx^{*1}, LM2901xxx^{*2}

^{*1}Last Time Buy.

^{*2}Partial Last Time Buy.

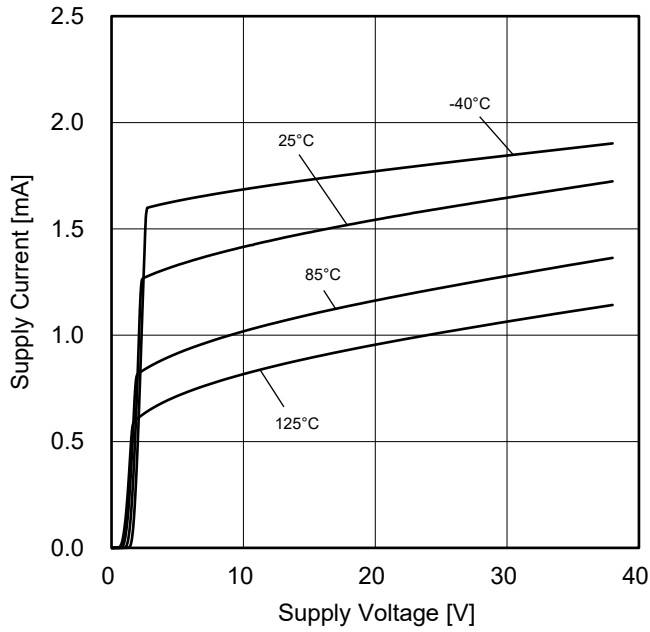

Figure 20. Supply Current vs Supply Voltage

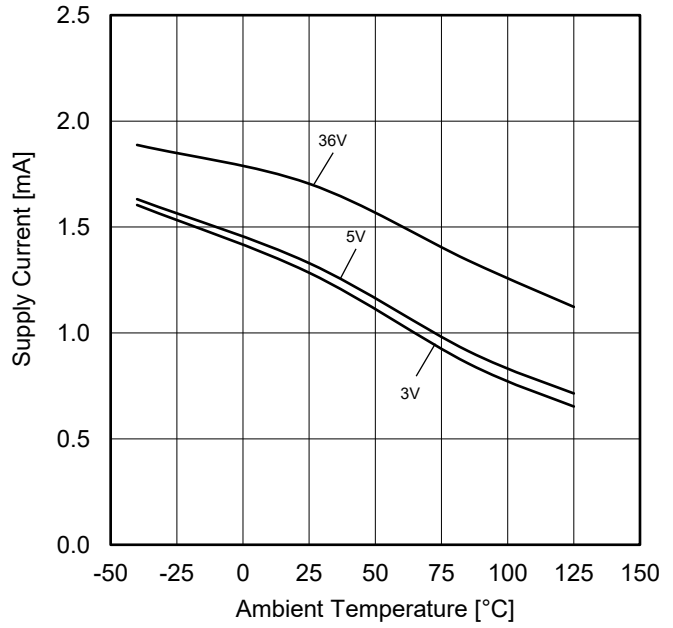

Figure 21. Supply Current vs Ambient Temperature

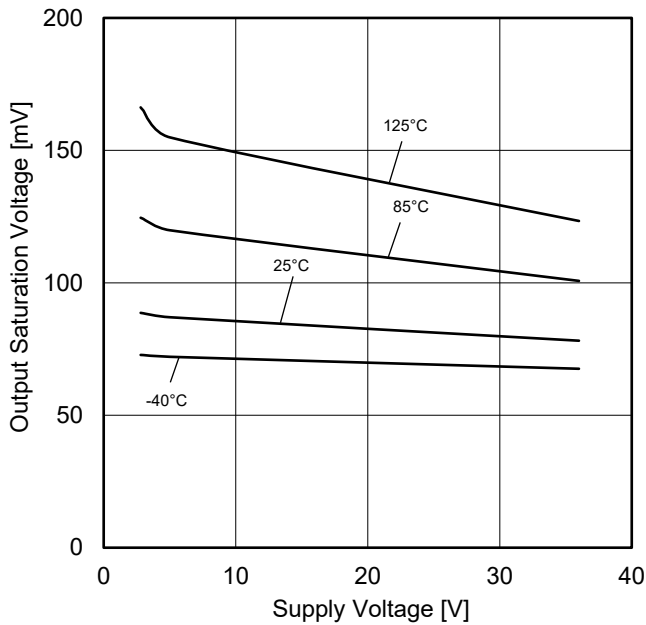

Figure 22. Output Saturation Voltage vs Supply Voltage ($I_{SINK}=4mA$)

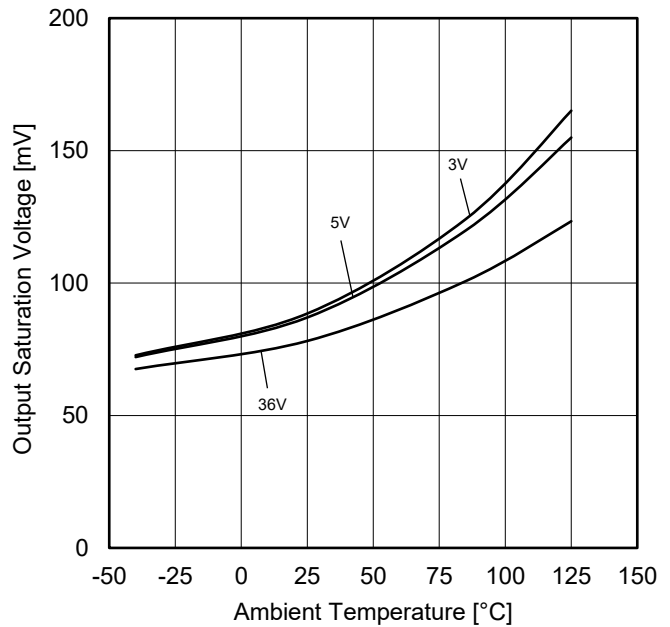

Figure 23. Output Saturation Voltage vs Ambient Temperature ($I_{SINK}=4mA$)

(*) The above data are measurement values of a typical sample, it is not guaranteed.

LM339xxx: -40°C to +85°C LM2901xxx: -40°C to +125°C

Typical Performance Curves - continued

OLM339xxx^{*1}, LM2901xxx^{*2}

*1 Last Time Buy.

*2 Partial Last Time Buy.

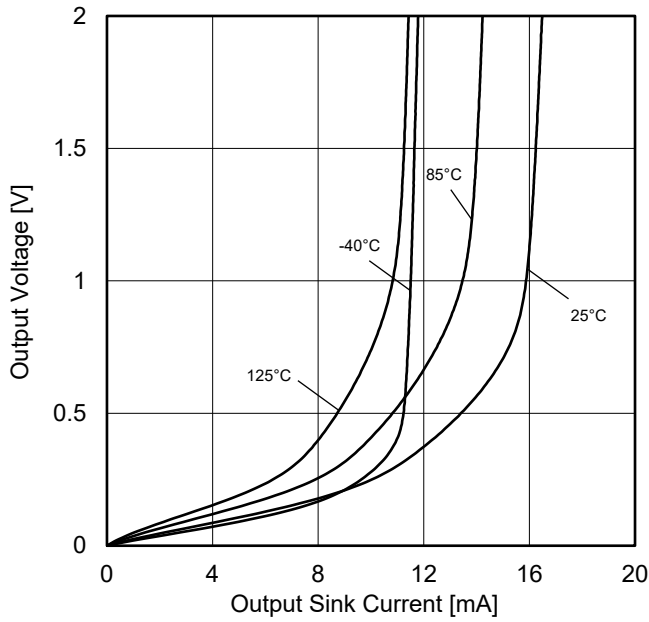

Figure 24. Output Voltage vs Output Sink Current (V_{CC}=5V)

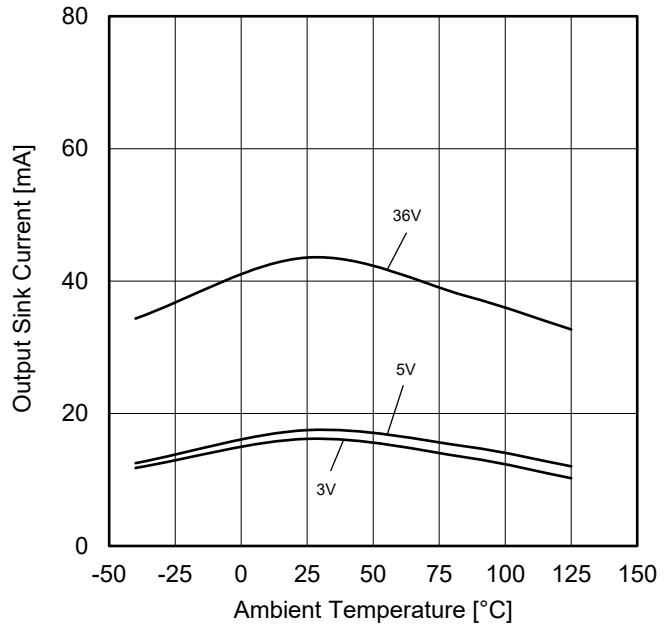

Figure 25. Output Sink Current vs Ambient Temperature (V_{OUT}=V_{CC})

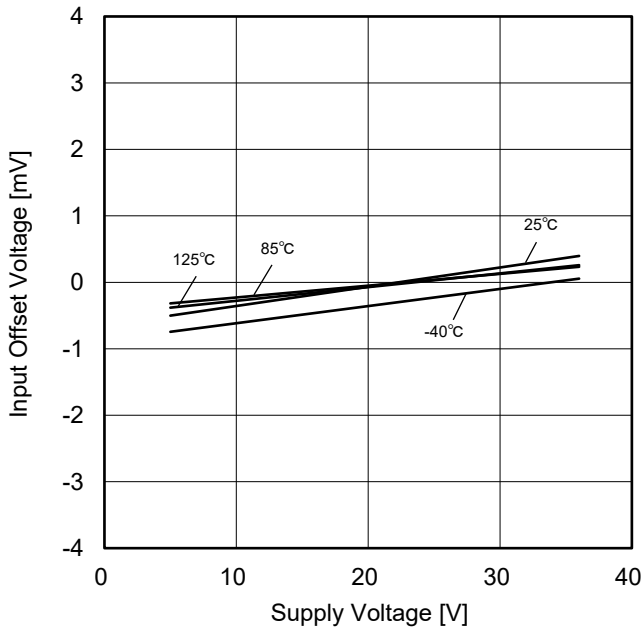

Figure 26. Input Offset Voltage vs Supply Voltage

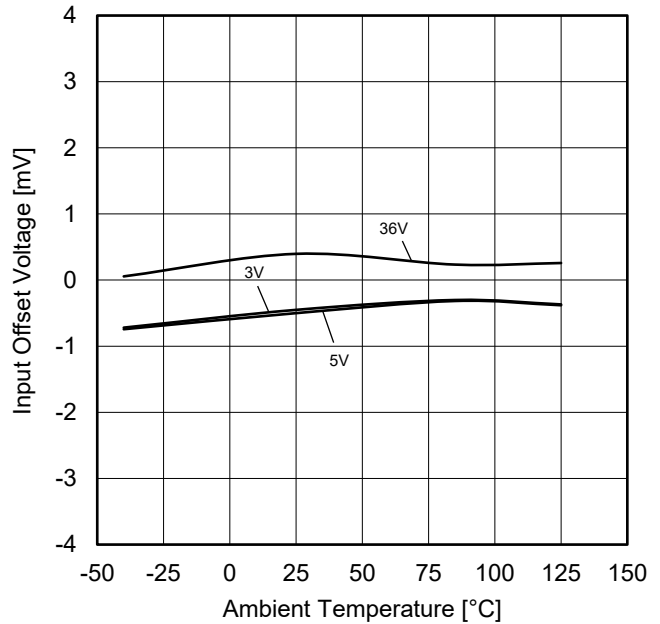

Figure 27. Input Offset Voltage vs Ambient Temperature

(*) The above data are measurement values of a typical sample, it is not guaranteed.

LM339xxx: -40°C to +85°C LM2901xxx: -40°C to +125°C

Typical Performance Curves - continued

OLM339xxx^{*1}, LM2901xxx^{*2}

*1 Last Time Buy.

*2 Partial Last Time Buy.

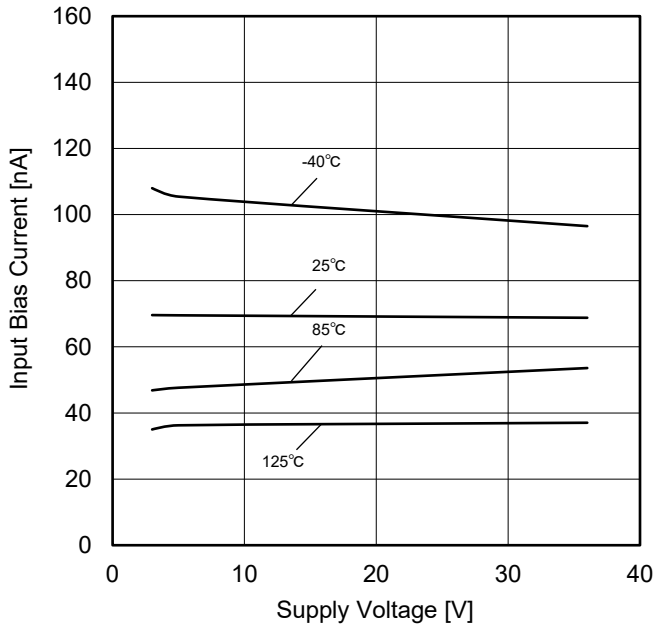

Figure 28. Input Bias Current vs Supply Voltage

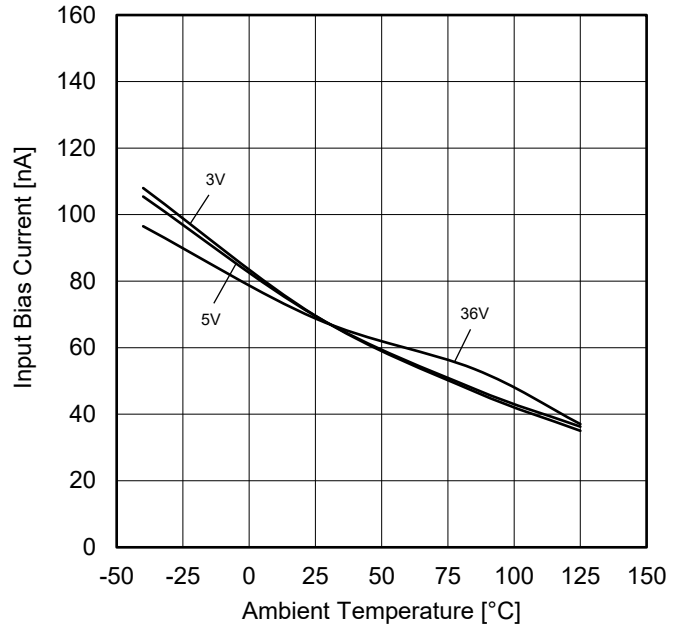

Figure 29. Input Bias Current vs Ambient Temperature

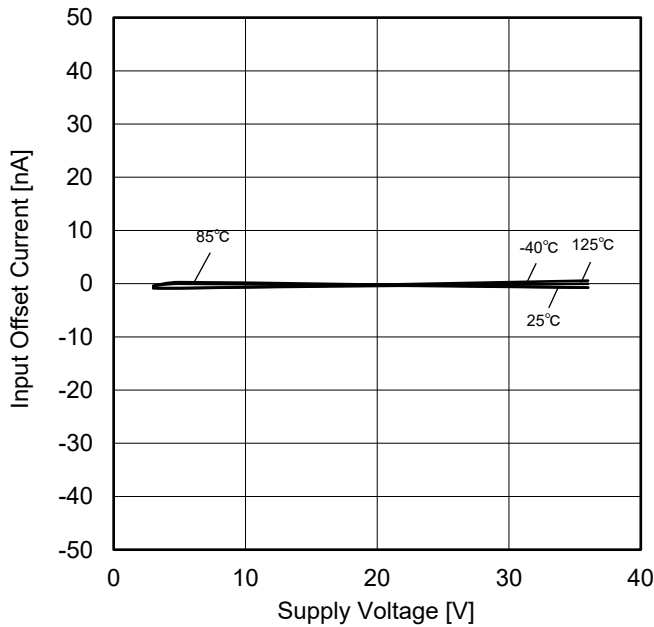

Figure 30. Input Offset Current vs Supply Voltage

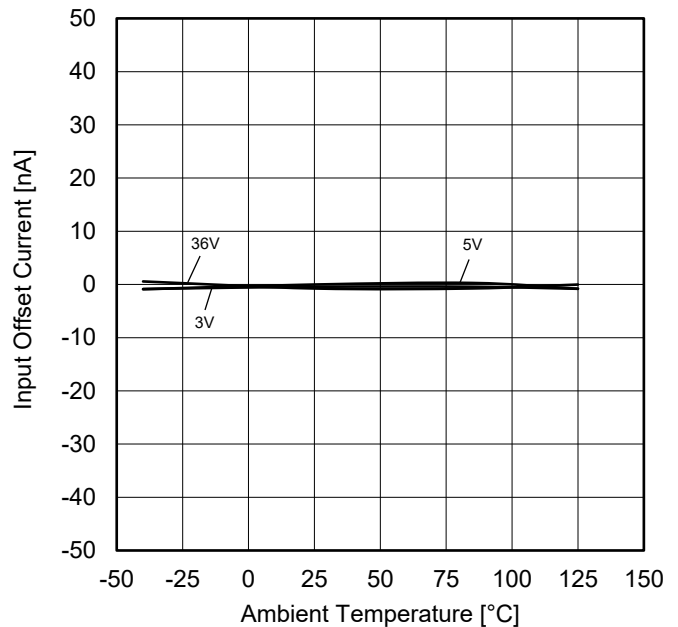

Figure 31. Input Offset Current vs Ambient Temperature

(*) The above data are measurement values of a typical sample, it is not guaranteed.

LM339xxx: -40°C to +85°C LM2901xxx: -40°C to +125°C

Typical Performance Curves - continued

OLM339xxx*1, LM2901xxx*2

*1 Last Time Buy.

*2 Partial Last Time Buy.

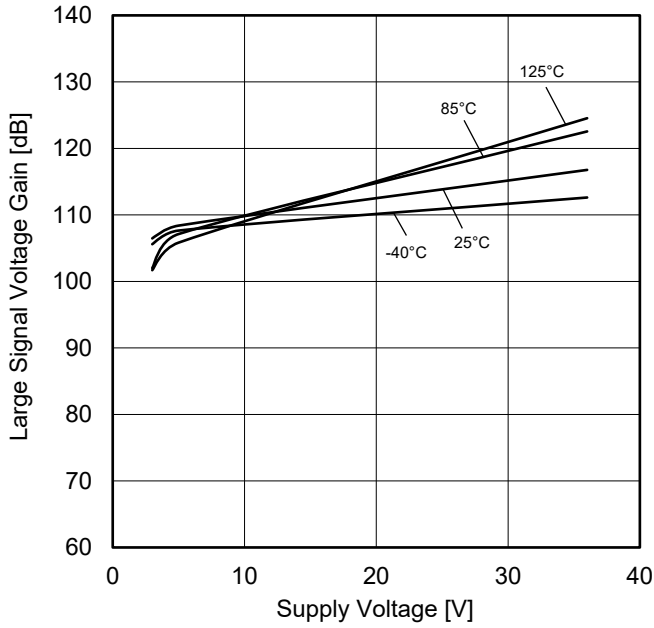

Figure 32. Large Signal Voltage Gain vs Supply Voltage ($R_L=15k\Omega$)

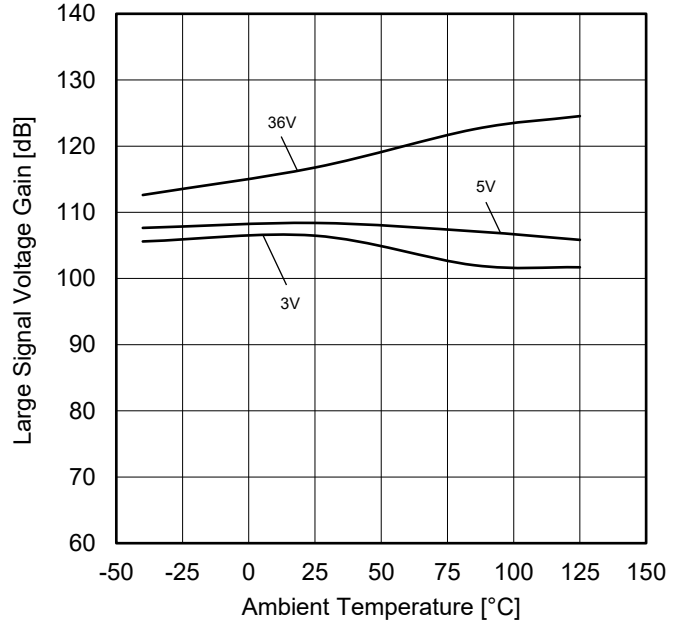

Figure 33. Large Signal Voltage Gain vs Ambient Temperature ($R_L=15k\Omega$)

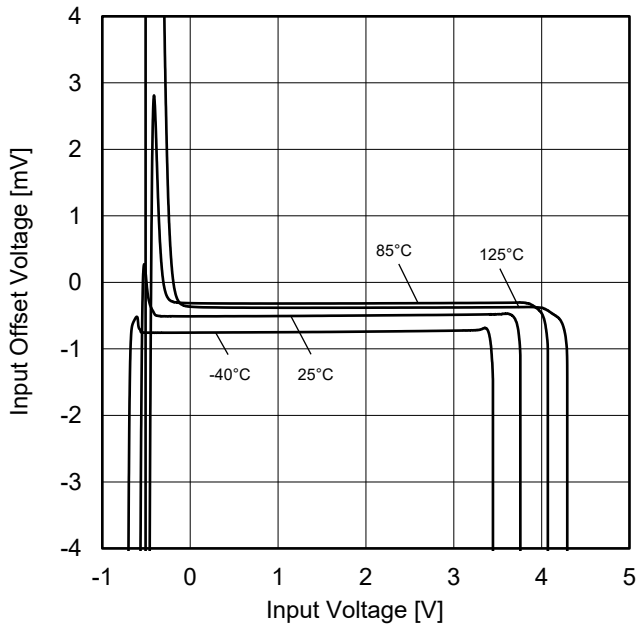

Figure 34. Input Offset Voltage vs Input Voltage ($V_{CC}=5V$)

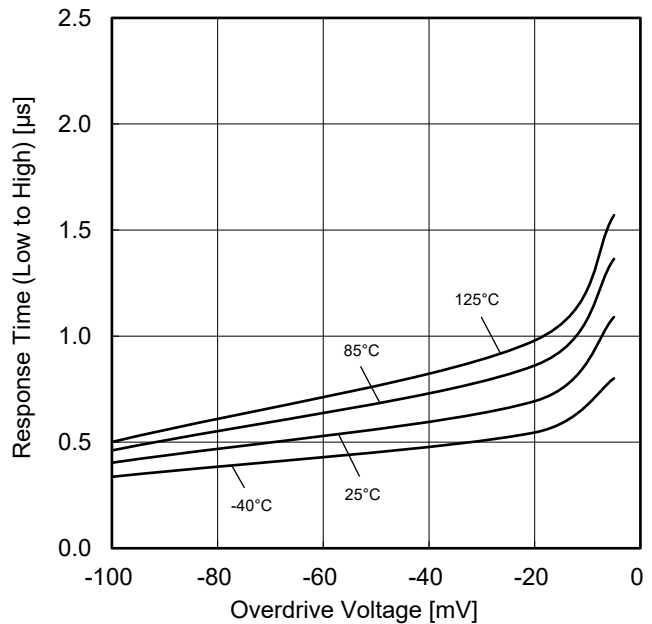

Figure 35. Response Time (Low to High) vs Overdrive Voltage ($V_{CC}=5V, V_{RL}=5V, R_L=5.1k\Omega$)

(*) The above data are measurement values of a typical sample, it is not guaranteed.

LM339xxx: -40°C to +85°C LM2901xxx: -40°C to +125°C

Typical Performance Curves - continued

○ LM339xxx^{*1}, LM2901xxx^{*2}

*1 Last Time Buy.

*2 Partial Last Time Buy.

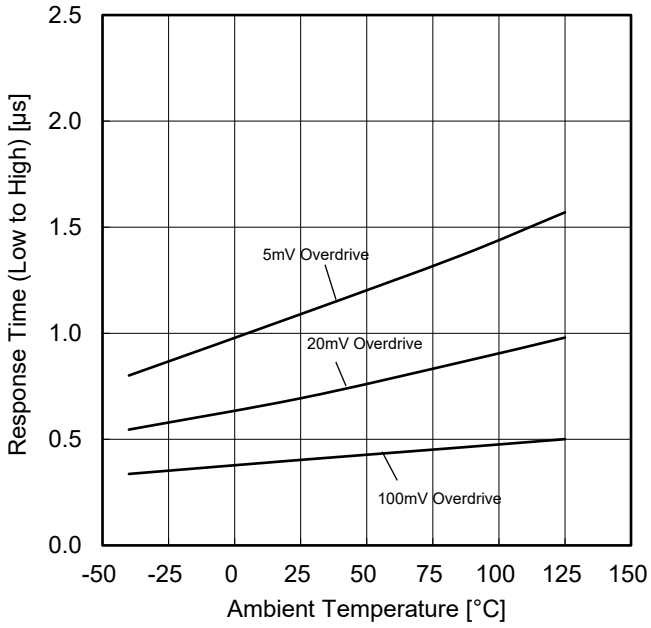

Figure 36. Response Time (Low to High) vs Ambient Temperature ($V_{CC}=5V$, $V_{RL}=5V$, $R_L=5.1k\Omega$)

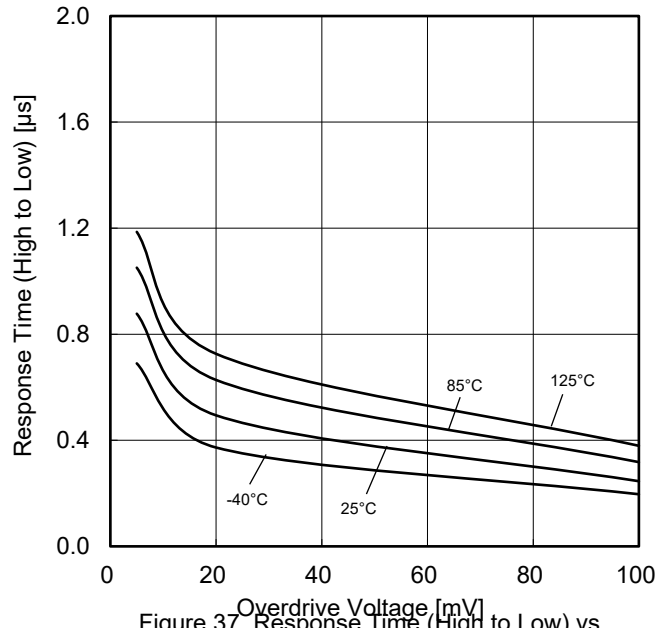

Figure 37. Response Time (High to Low) vs Overdrive Voltage ($V_{CC}=5V$, $V_{RL}=5V$, $R_L=5.1k\Omega$)

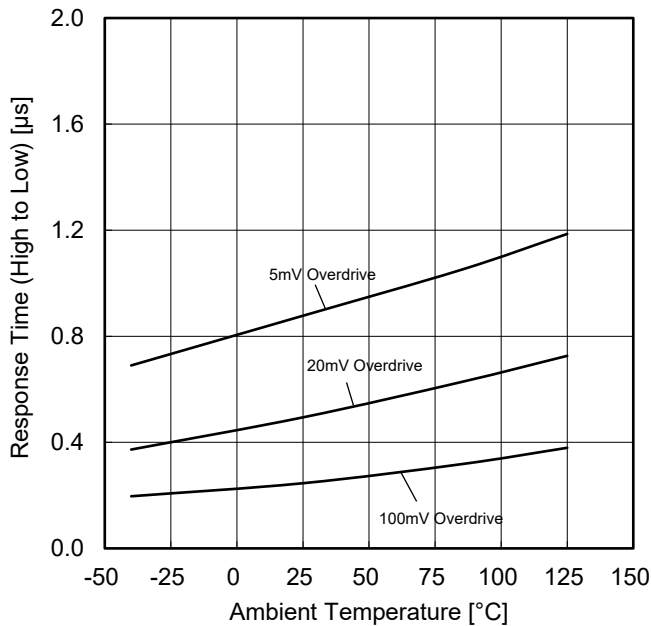

Figure 38. Response Time (High to Low) vs Ambient Temperature ($V_{CC}=5V$, $V_{RL}=5V$, $R_L=5.1k\Omega$)

(*) The above data are measurement values of a typical sample, it is not guaranteed.
 LM339xxx: -40°C to +85°C LM2901xxx: -40°C to +125°C

Application Information

NULL method condition for Test Circuit 1

V_{CC}, V_{EE}, E_K, V_{ICM}, V_{RL} Unit: V; R_L Unit: Ohms

Parameter	V _F	SW1	SW2	SW3	V _{CC}	V _{EE}	E _K	V _{ICM}	V _{RL}	R _L	Calculation
Input Offset Voltage	V _{F1}	ON	ON	ON	5 to 32	0	-1.4	0	5 to 32	5.1k	1
Input Offset Current	V _{F2}	OFF	OFF	ON	5	0	-1.4	0	5	10k	2
Input Bias Current	V _{F3}	OFF	ON	ON	5	0	-1.4	0	5	10k	3
	V _{F4}	ON	OFF								
Large Signal Voltage Gain	V _{F5}	ON	ON	ON	15	0	-1.4	0	15	15k	4
	V _{F6}						-11.4				

- Calculation -

1. Input Offset Voltage (V_{IO})

$$V_{IO} = \frac{|V_{F1}|}{1 + R_f/R_s} \text{ [V]}$$

2. Input Offset Current (I_{IO})

$$I_{IO} = \frac{|V_{F2} - V_{F1}|}{R_i \times (1 + R_f/R_s)} \text{ [A]}$$

3. Input Bias Current (I_B)

$$I_B = \frac{|V_{F4} - V_{F3}|}{2 \times R_i \times (1 + R_f/R_s)} \text{ [A]}$$

4. Large Signal Voltage Gain (A_v)

$$A_v = 20 \text{Log} \frac{\Delta E_K \times (1 + R_f/R_s)}{|V_{F6} - V_{F5}|} \text{ [dB]}$$

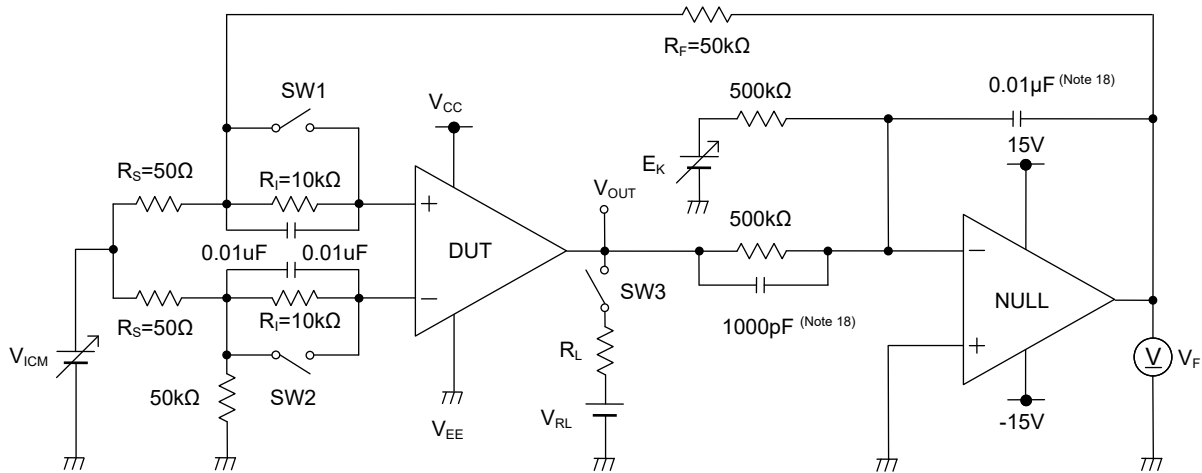

(Note 18) Use 1uF capacitor for Input Bias Current and Input Offset Current

Figure 39. Test Circuit 1 (One Channel Only)

Application Information – continued
 Switch Condition for Test Circuit 2

Parameter		SW1	SW2	SW3	SW4	SW5	SW6	SW7
Supply Current		ON	ON	OFF	OFF	OFF	OFF	OFF
Output Sink Current	$V_{OUT}=1.5V$	ON	ON	OFF	OFF	OFF	OFF	ON
Output Saturation Voltage	$I_{SINK}=4mA$	ON	ON	OFF	OFF	ON	ON	OFF
Output Leakage Current	$V_{OUT}=32V$	ON	ON	OFF	OFF	OFF	OFF	ON
Response Time	$R_L=5.1k\Omega, V_{RL}=5V$	ON	OFF	ON	ON	OFF	OFF	OFF

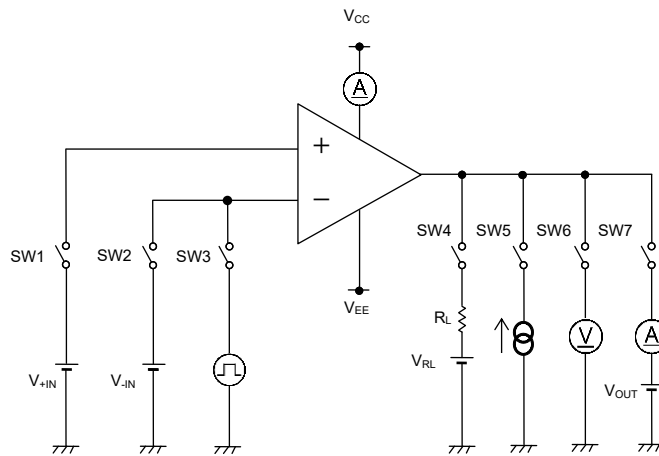

Figure 40. Test Circuit 2 (One Channel Only)

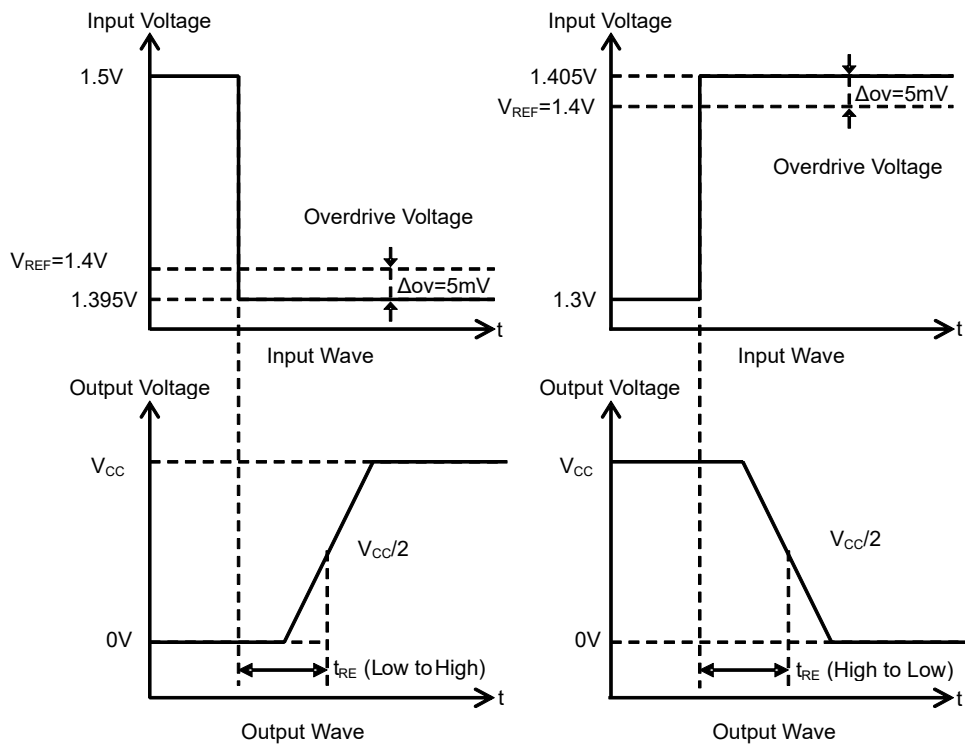

Figure 41. Response Time

Application Information – continued

1. Unused Circuits

It is recommended to apply the connection (see Figure 42) and set the non-inverting input pin at a potential within the Input Common-mode Voltage Range (V_{ICM}) for any unused circuit.

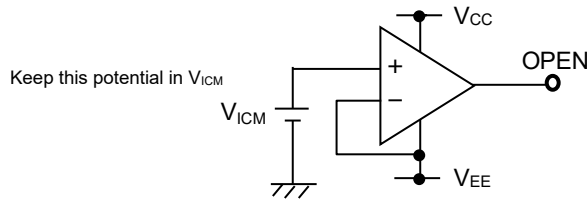

Figure 42. Example of Application Circuit for Unused Comparator

2. Input Pin Voltage

Regardless of the supply voltage, applying $V_{EE}+32V$ to the input pin is possible without causing deterioration of the electrical characteristics or destruction. However, this does not ensure normal circuit operation. Please note that the circuit operates normally only when the input voltage is within the common mode input voltage range of the electric characteristics.

3. Power Supply (Single/Dual)

The comparators operate when the voltage supplied is between V_{CC} pin and V_{EE} pin. Therefore, the single supply comparators can be used as dual supply comparators as well.

4. IC Handling

When pressure is applied to the IC through warp on the printed circuit board, the characteristics may fluctuate due to the piezoelectric effect. Be careful of warps on the printed circuit board.

I/O Equivalent Circuit

Symbol	Pin No.	Equivalent Circuit
+IN -IN	LM393xxx ^{*1} , LM2903xxx ^{*2} : 2,3,5,6 LM339xxx ^{*1} , LM2901xxx ^{*2} : 4,5,6,7,8,9,10,11	
OUT	LM393xxx ^{*1} , LM2903xxx ^{*2} : 1,7 LM339xxx ^{*1} , LM2901xxx ^{*2} : 1,2,13,14	
VCC	LM393xxx ^{*1} , LM2903xxx ^{*2} : 8 LM339xxx ^{*1} , LM2901xxx ^{*2} : 3	

^{*1}Last Time Buy.

^{*2}Partial Last Time Buy.

Example of Circuit

○Reference voltage is V_{-IN}

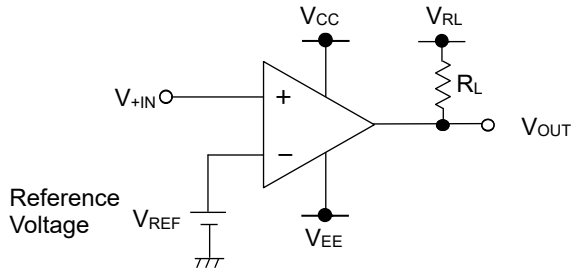

When the input voltage is bigger than reference voltage, output voltage is high. When the input voltage is smaller than reference voltage, output voltage is low.

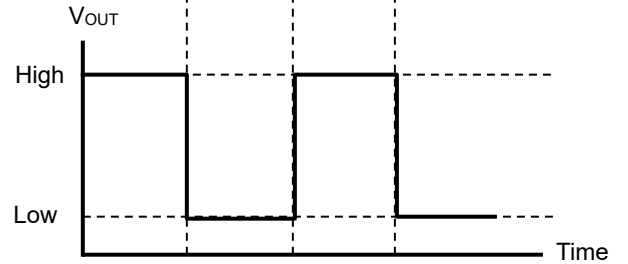
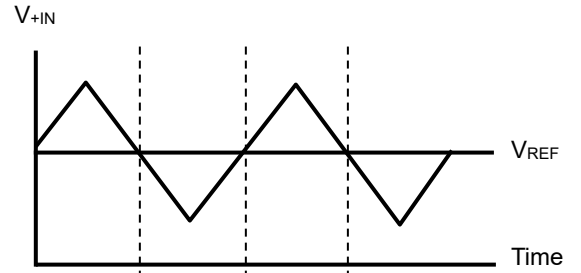

○Reference voltage is V_{+IN}

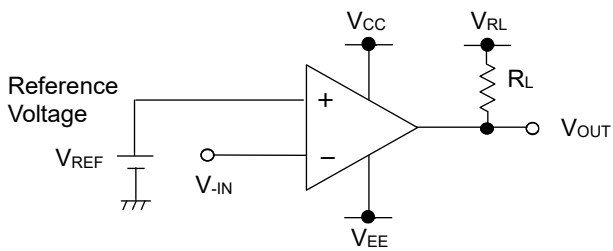

When the input voltage is smaller than reference voltage, output voltage is high. When the input voltage is bigger than reference voltage, output voltage is low.

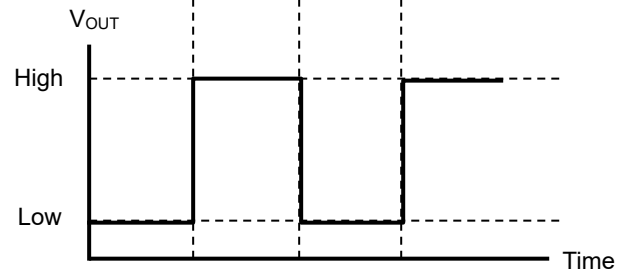
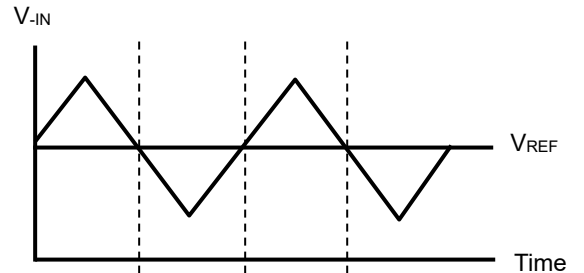

Power Dissipation

Power dissipation (total loss) indicates the power that the IC can consume at $T_A=25^\circ\text{C}$ (normal temperature). As the IC consumes power, it heats up, causing its temperature to be higher than the ambient temperature. The allowable temperature that the IC can accept is limited. This depends on the circuit configuration, manufacturing process, and consumable power. Power dissipation is determined by the allowable temperature within the IC (maximum junction temperature) and the thermal resistance of the package used (heat dissipation capability). Maximum junction temperature is typically equal to the maximum storage temperature. The heat generated through the consumption of power by the IC radiates from the mold resin or lead frame of the package. Thermal resistance, represented by the symbol $\theta_{JA}^\circ\text{C/W}$, indicates this heat dissipation capability. Similarly, the temperature of an IC inside its package can be estimated by thermal resistance. Figure 43(a) shows the model of the thermal resistance of a package. The equation below shows how to compute for the Thermal resistance (θ_{JA}), given the ambient temperature (T_A), maximum junction temperature (T_{jmax}), and power dissipation (P_D).

$$\theta_{JA} = (T_{jmax} - T_A) / P_D \quad ^\circ\text{C/W}$$

The Derating curve in Figure 43(b) indicates the power that the IC can consume with reference to ambient temperature. Power consumption of the IC begins to attenuate at certain temperatures. This gradient is determined by Thermal resistance (θ_{JA}), which depends on the chip size, power consumption, package, ambient temperature, package condition, wind velocity, etc. This may also vary even when the same package is used. Thermal reduction curve indicates a reference value measured at a specified condition. Figure 43(c) to (f) show the examples of the derating curves for LM393xxx, LM2903xxx, LM339xxx, and LM2901xxx respectively.

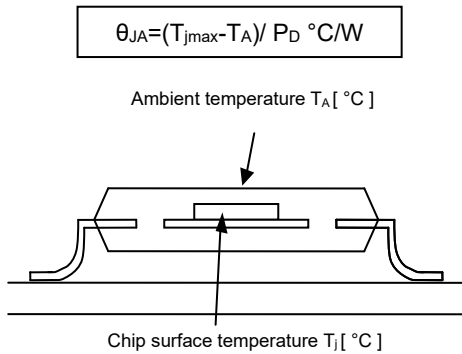

(a) Thermal Resistance

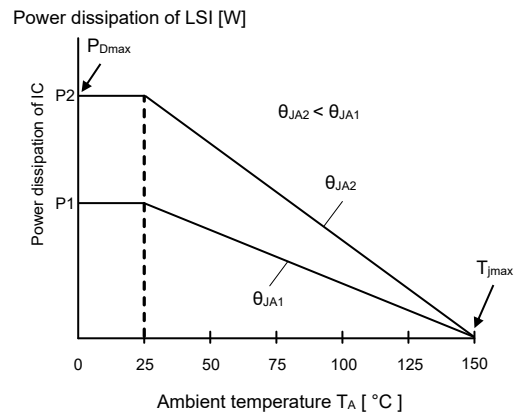

(b) Derating Curve

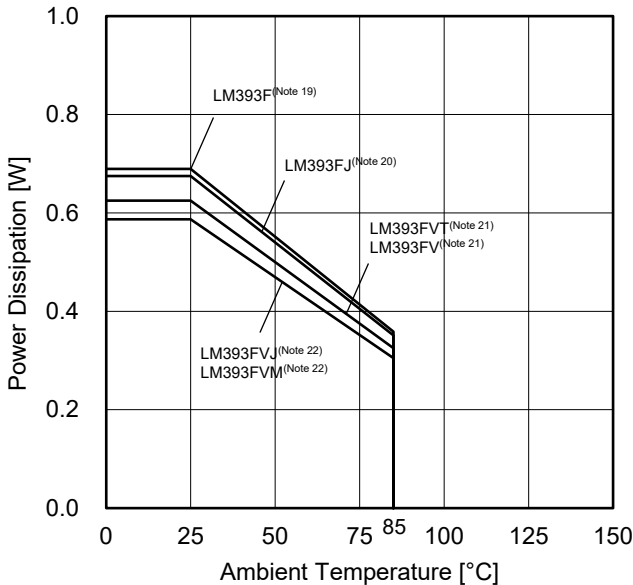

(c) LM393xxx*1

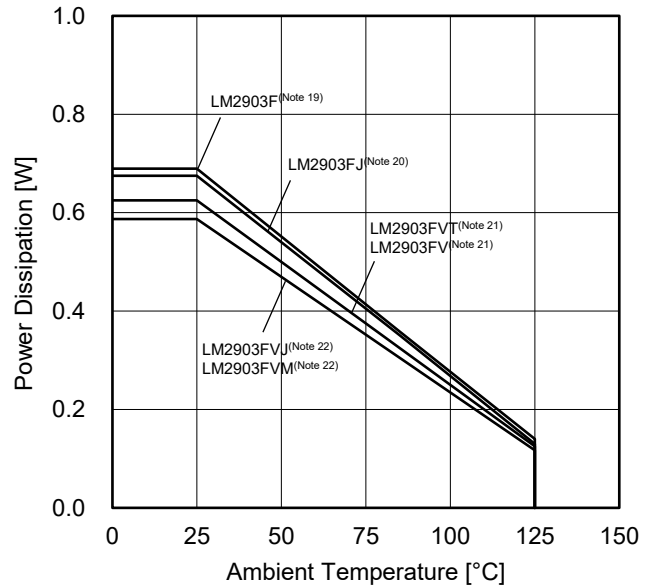

(d) LM2903xxx*2

*1 Last Time Buy.
*2 Partial Last Time Buy.

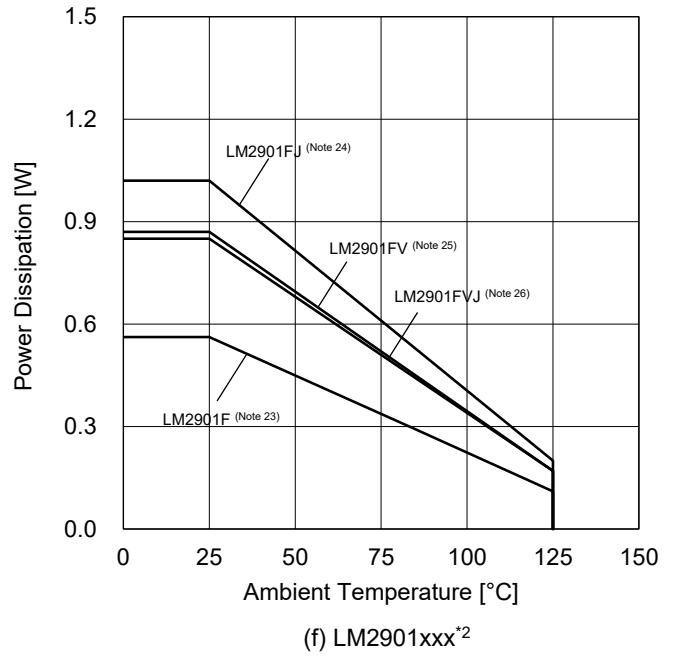
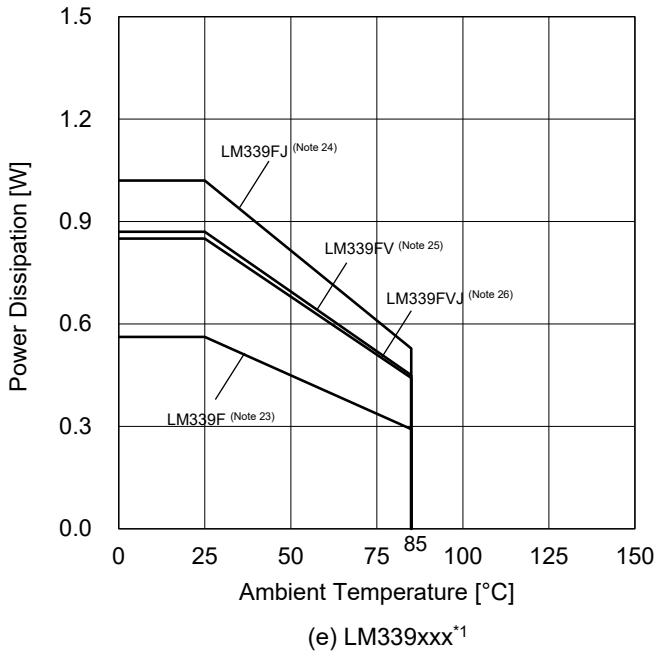

*1 Last Time Buy.
*2 Partial Last Time Buy.

Note 19	Note 20	Note 21	Note 22	Note 23	Note 24	Note 25	Note 26	Unit
5.5	5.4	5.0	4.7	4.5	8.2	7.0	6.8	mW/°C

Reduce the value above per 1°C above 25°C.

Power dissipation is the value when the IC mounted on FR4 glass epoxy board 70mm ×70mm ×1.6mm (cooper foil area below 3%) is mounted.

Figure 43. Thermal Resistance and Derating Curve

Operational Notes

1. Reverse Connection of Power Supply

Connecting the power supply in reverse polarity can damage the IC. Take precautions against reverse polarity when connecting the power supply, such as mounting an external diode between the power supply and the IC's power supply terminals.

2. Power Supply Lines

Design the PCB layout pattern to provide low impedance ground and supply lines. Separate the ground and supply lines of the digital and analog blocks to prevent noise in the ground and supply lines of the digital block from affecting the analog block. Furthermore, connect a capacitor to ground at all power supply pins. Consider the effect of temperature and aging on the capacitance value when using electrolytic capacitors.

3. Ground Voltage

Ensure that no pins are at a voltage below that of the ground pin at any time, even during transient condition.

4. Ground Wiring Pattern

When using both small-signal and large-current GND traces, the two ground traces should be routed separately but connected to a single ground at the reference point of the application board to avoid fluctuations in the small-signal ground caused by large currents. Also ensure that the GND traces of external components do not cause variations on the GND voltage. The power supply and ground lines must be as short and thick as possible to reduce line impedance.

5. Thermal Consideration

Should by any chance the power dissipation rating be exceeded, the rise in temperature of the chip may result in deterioration of the properties of the chip. The absolute maximum rating of the Pd stated in this specification is when the IC is mounted on a 70mm x 70mm x 1.6mm glass epoxy board. In case of exceeding this absolute maximum rating, increase the board size and copper area to prevent exceeding the Pd rating.

6. Recommended Operating Conditions

These conditions represent a range within which the expected characteristics of the IC can be approximately obtained. The electrical characteristics are guaranteed under the conditions of each parameter.

7. Inrush Current

When power is first supplied to the IC, it is possible that the internal logic may be unstable and inrush current may flow instantaneously due to the internal powering sequence and delays, especially if the IC has more than one power supply. Therefore, give special consideration to power coupling capacitance, power wiring, width of GND wiring, and routing of connections.

8. Operation Under Strong Electromagnetic Field

Operating the IC in the presence of a strong electromagnetic field may cause the IC to malfunction.

9. Testing on Application Boards

When testing the IC on an application board, connecting a capacitor directly to a low-impedance output pin may subject the IC to stress. Always discharge capacitors completely after each process or step. The IC's power supply should always be turned off completely before connecting or removing it from the test setup during the inspection process. To prevent damage from static discharge, ground the IC during assembly and use similar precautions during transport and storage.

10. Inter-pin Short and Mounting Errors

Ensure that the direction and position are correct when mounting the IC on the PCB. Incorrect mounting may result in damaging the IC. Avoid nearby pins being shorted to each other especially to ground. Inter-pin shorts could be due to many reasons such as metal particles, water droplets (in very humid environment) and unintentional solder bridge deposited in between pins during assembly to name a few.

Operational Notes – continued

11. Regarding Input Pins of the IC

This monolithic IC contains P+ isolation and P substrate layers between adjacent elements in order to keep them isolated. P-N junctions are formed at the intersection of the P layers with the N layers of other elements, creating a parasitic diode or transistor. For example (refer to figure below):

- When GND > Pin A and GND > Pin B, the P-N junction operates as a parasitic diode.
- When GND > Pin B, the P-N junction operates as a parasitic transistor.

Parasitic diodes inevitably occur in the structure of the IC. The operation of parasitic diodes can result in mutual interference among circuits, operational faults, or physical damage. Therefore, conditions that cause these diodes to operate, such as applying a voltage lower than the GND voltage to an input pin (and thus to the P substrate) should be avoided.

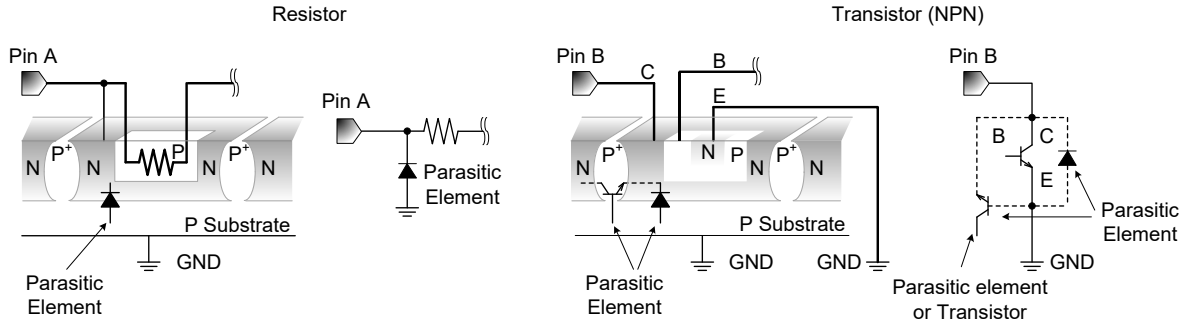
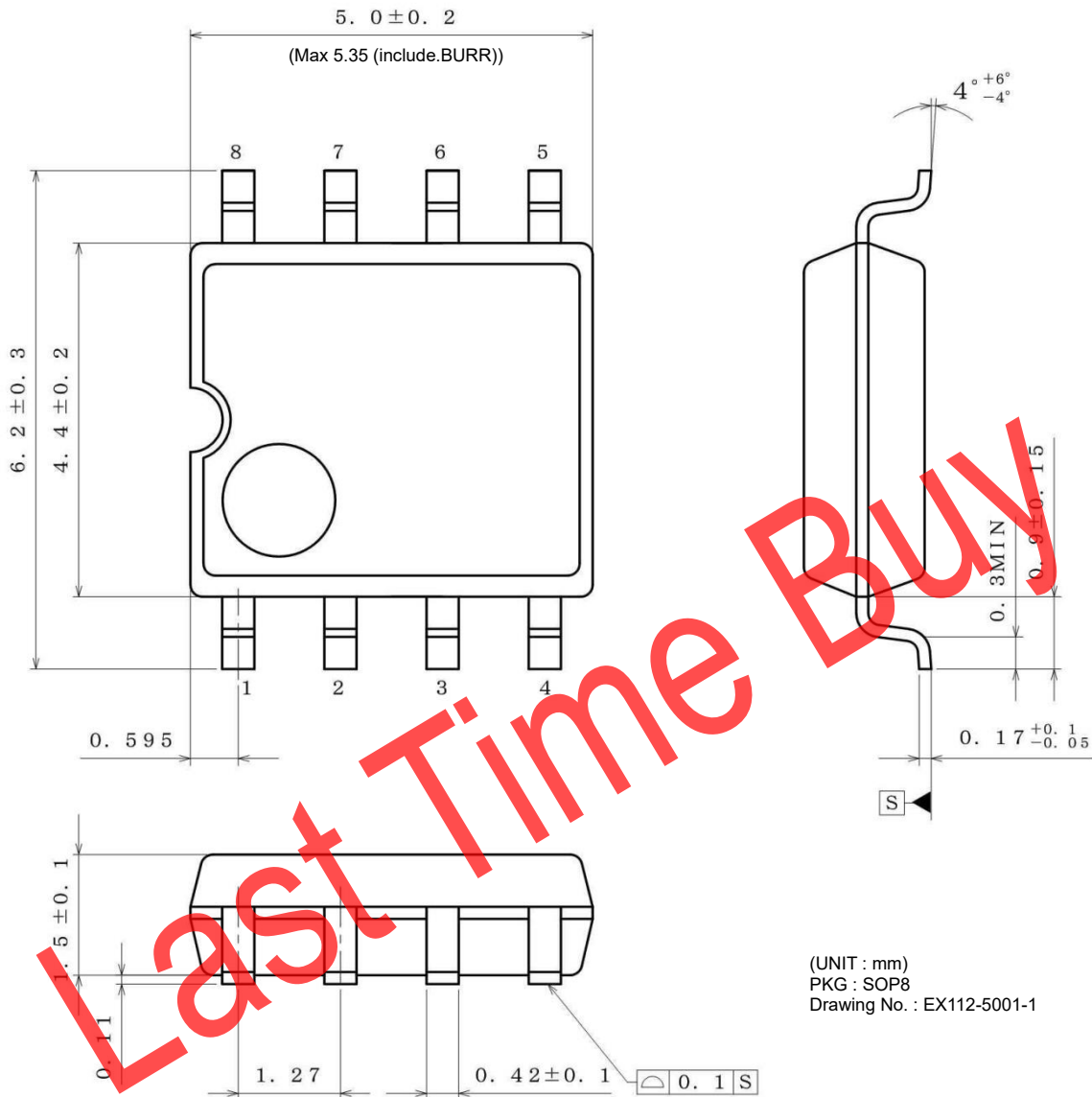

Figure 44. Example of Monolithic IC Structure

Physical Dimension Tape and Reel Information

Package Name	SOP8
--------------	------



(UNIT : mm)
 PKG : SOP8
 Drawing No. : EX112-5001-1

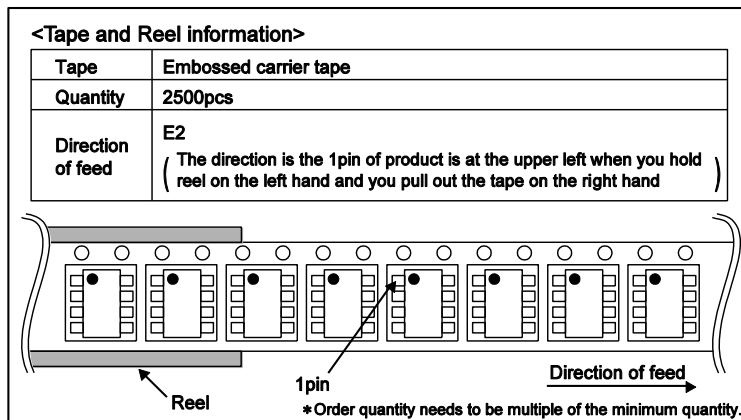

Physical Dimensions, Tape and Reel Information – continued

Package Name	SOP-J8
--------------	--------

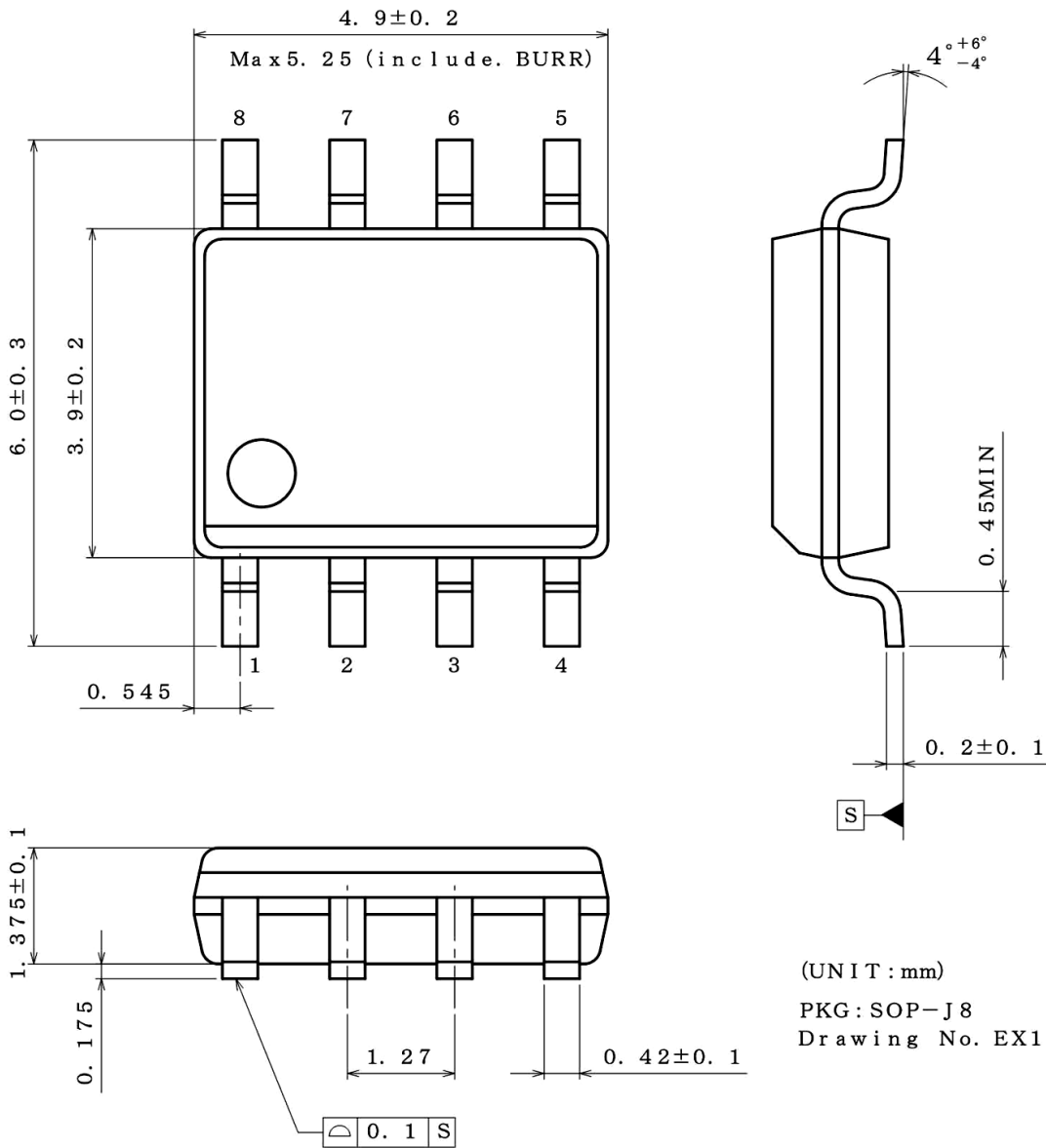

<Tape and Reel information>

Tape	Embossed carrier tape
Quantity	2500pcs
Direction of feed	E2 (The direction is the 1pin of product is at the upper left when you hold reel on the left hand and you pull out the tape on the right hand)

1pin
 *Order quantity needs to be multiple of the minimum quantity.

Physical Dimensions, Tape and Reel Information – continued

Package Name	SSOP-B8
--------------	---------

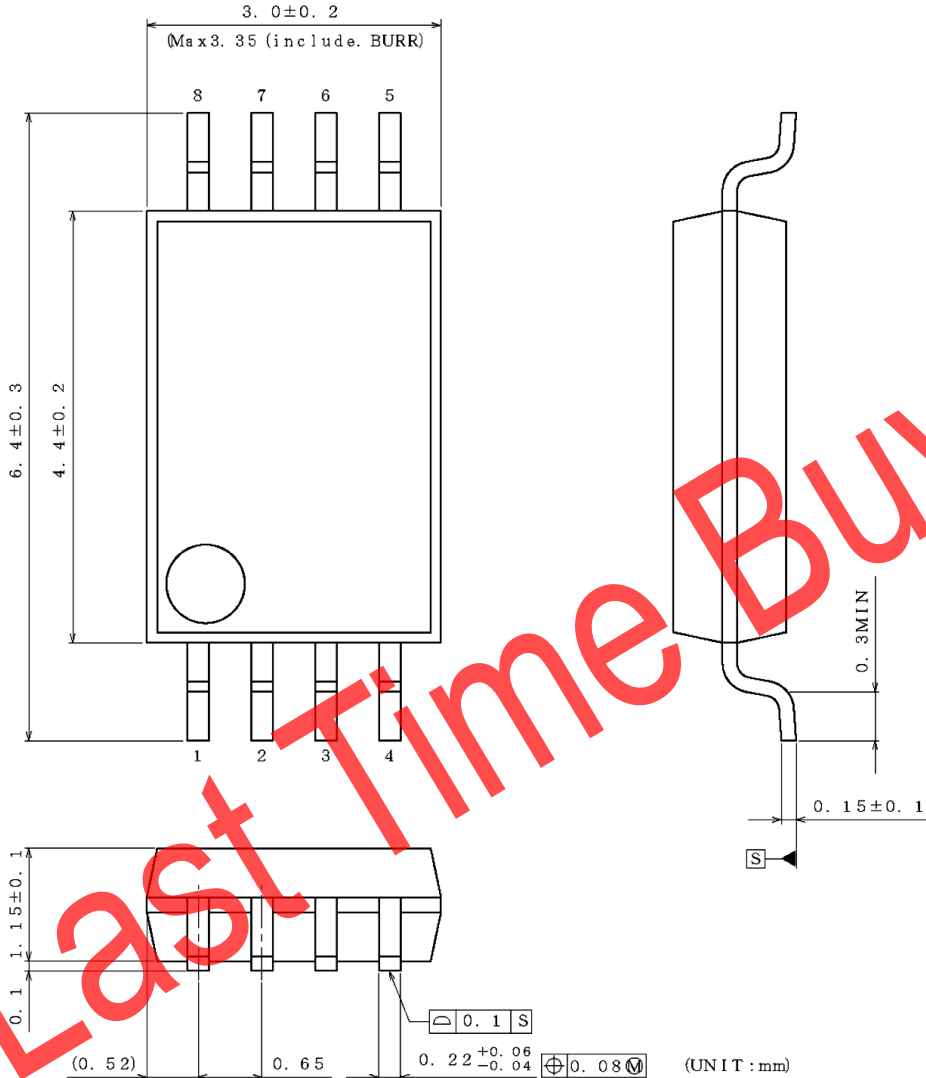

(UNIT : mm)
 PKG : SSOP-B8
 Drawing No. EX151-5002

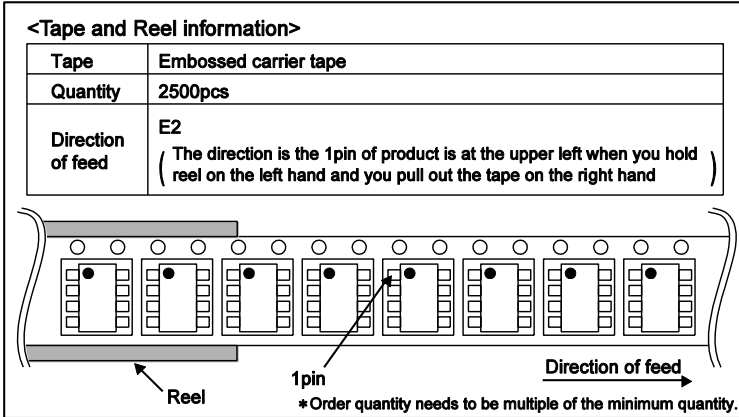

Physical Dimensions, Tape and Reel Information – continued

Package Name	TSSOP-B8
--------------	----------

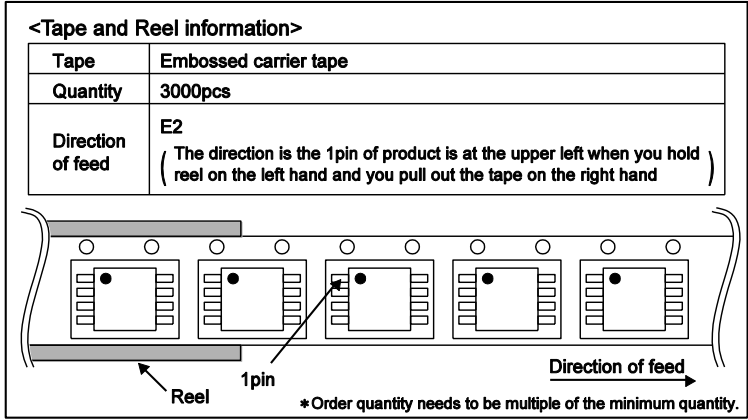
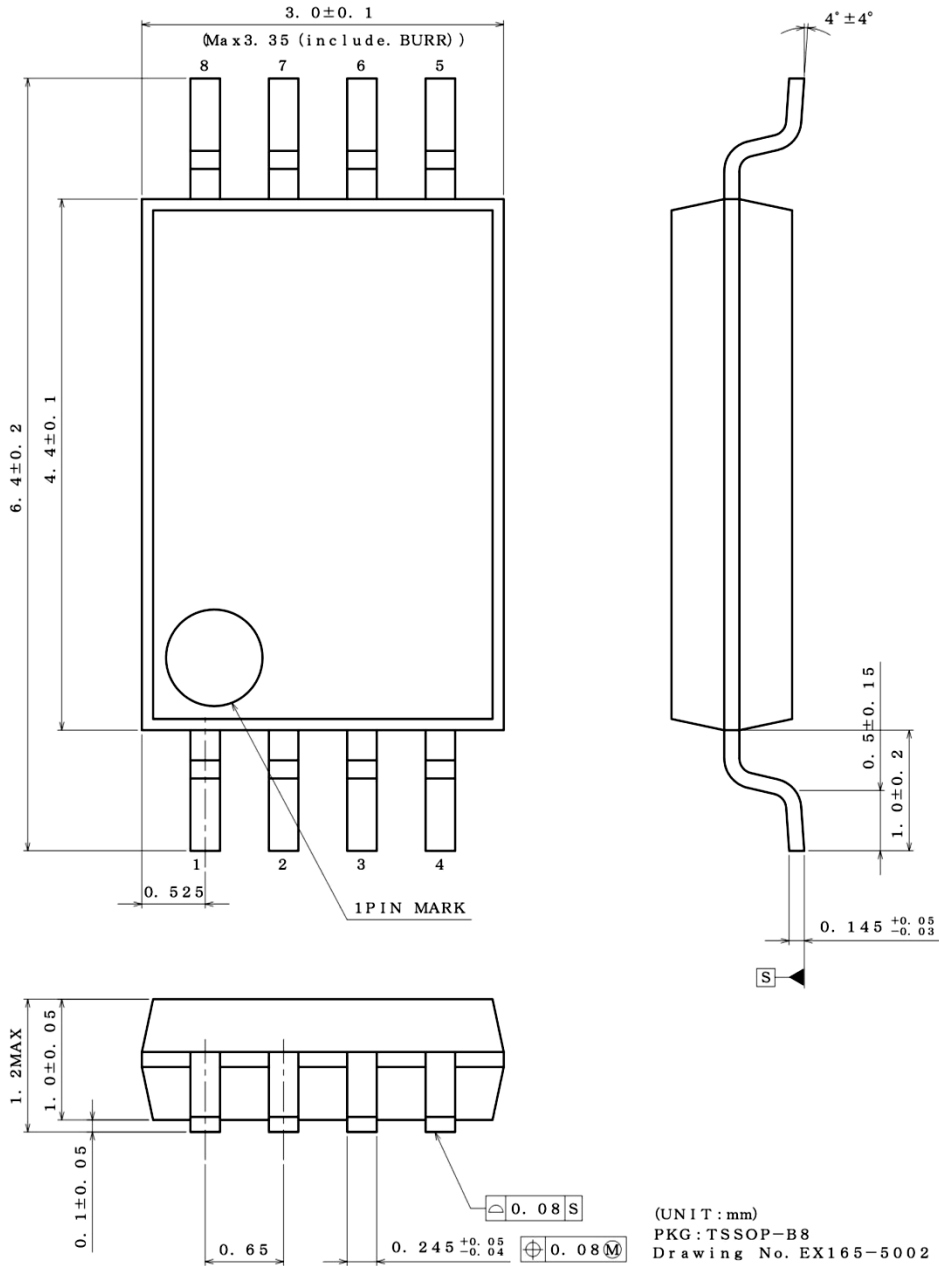

Physical Dimensions, Tape and Reel Information – continued

Package Name	TSSOP-B8J
--------------	-----------

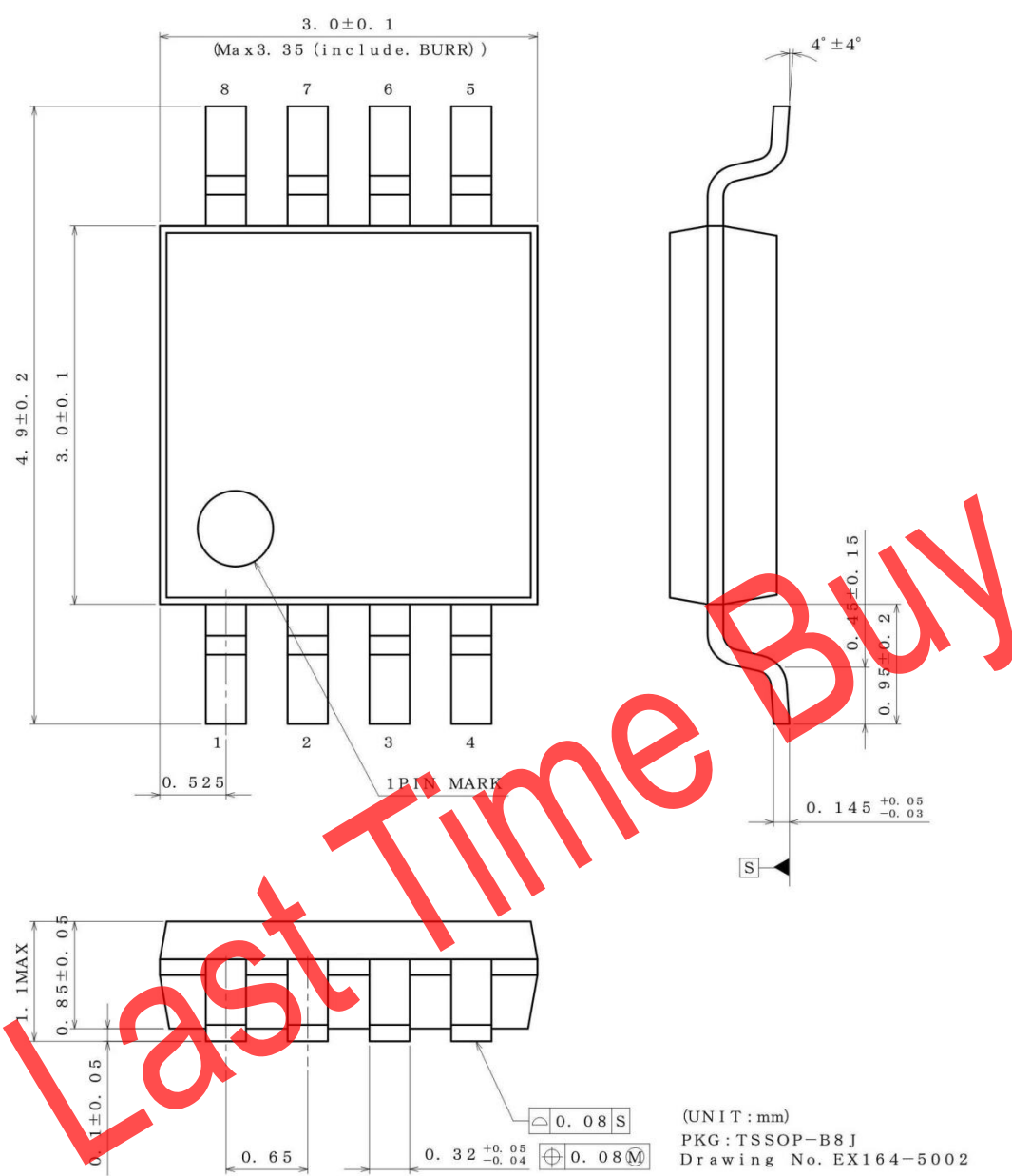

<Tape and Reel information>

Tape	Embossed carrier tape
Quantity	2500pcs
Direction of feed	E2 (The direction is the 1pin of product is at the upper left when you hold reel on the left hand and you pull out the tape on the right hand)

Reel

1pin

Direction of feed

*Order quantity needs to be multiple of the minimum quantity.

Physical Dimensions, Tape and Reel Information – continued

Package Name	MSOP8
--------------	-------

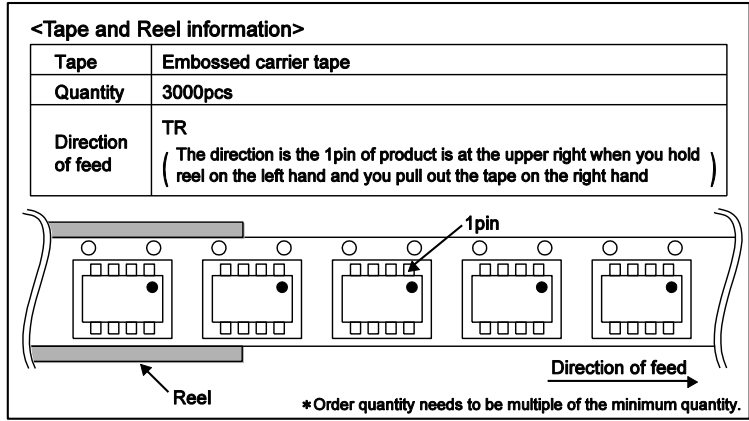
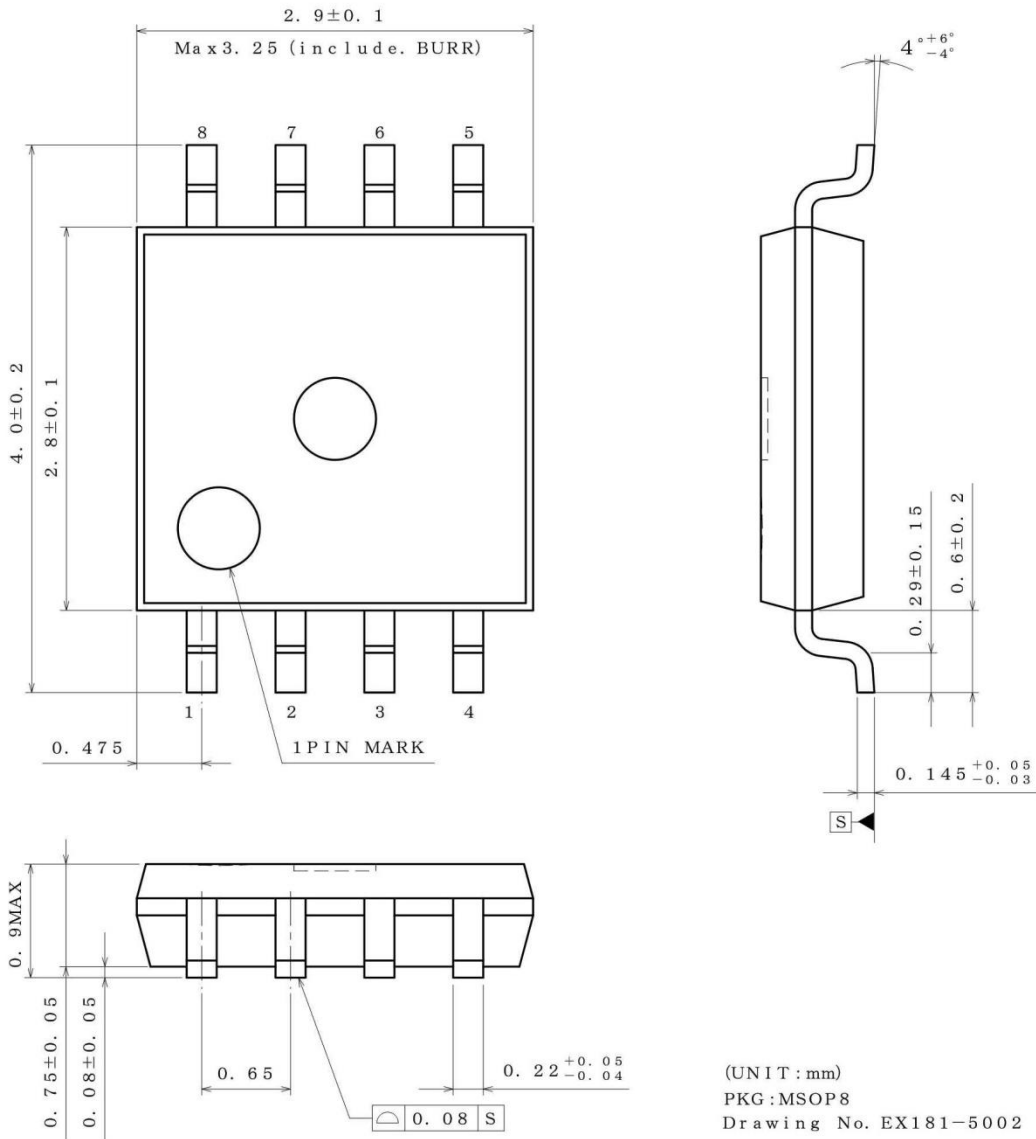

Physical Dimensions, Tape and Reel Information – continued

Package Name	SOP14
--------------	-------

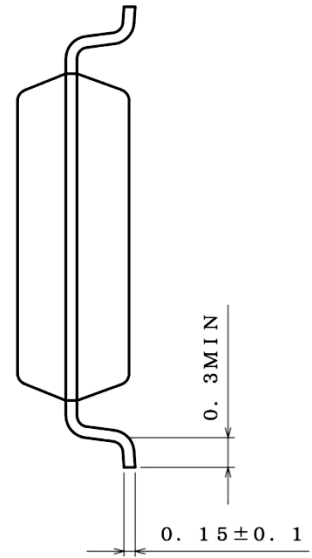
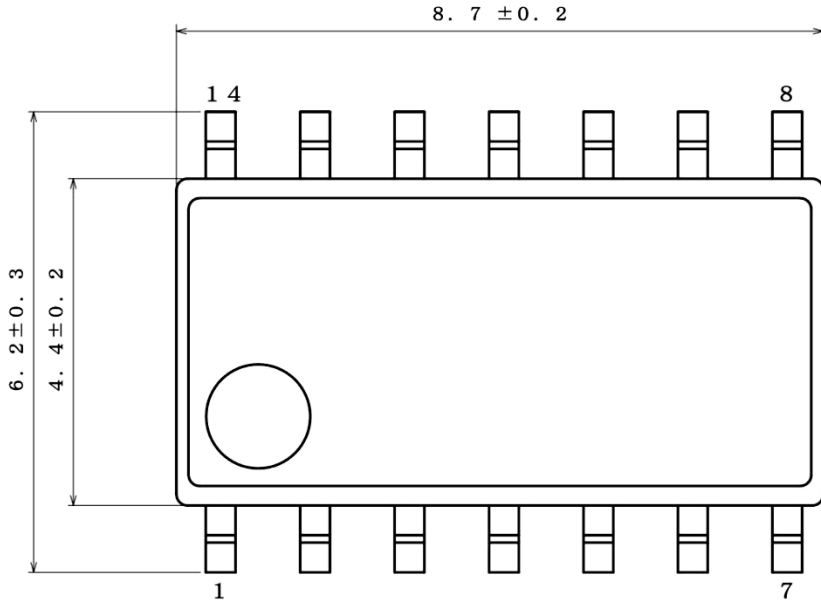

(UNIT : mm)
 PKG : SOP14
 Drawing No. : EX113-5001

<Tape and Reel information>

Tape	Embossed carrier tape
Quantity	2500pcs
Direction of feed	E2 (The direction is the 1pin of product is at the upper left when you hold reel on the left hand and you pull out the tape on the right hand)

Reel 1pin Direction of feed

*Order quantity needs to be multiple of the minimum quantity.

Physical Dimensions, Tape and Reel Information – continued

Package Name	SOP-J14
--------------	---------

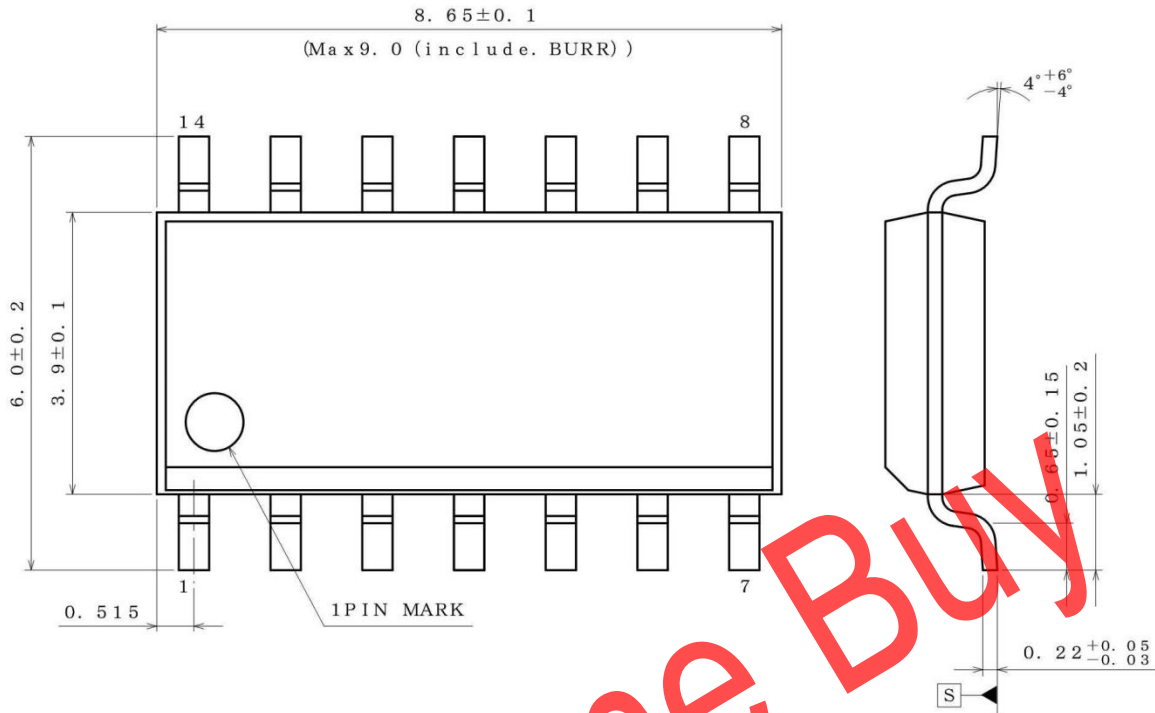

(UNIT : mm)

PKG : SOP-J14

Drawing No. EX126-5002-1

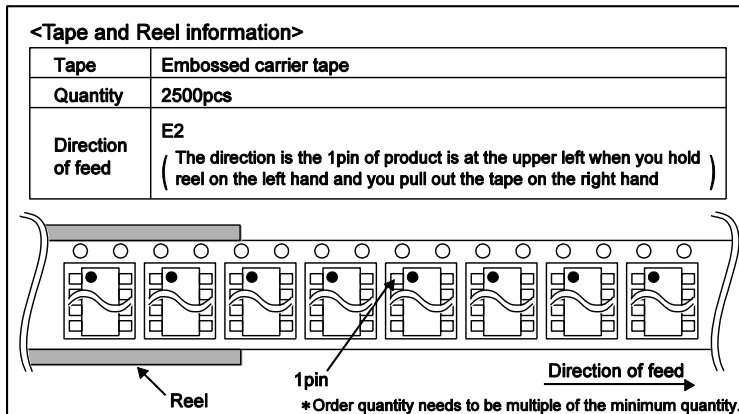

Physical Dimensions, Tape and Reel Information – continued

Package Name	SSOP-B14
--------------	----------

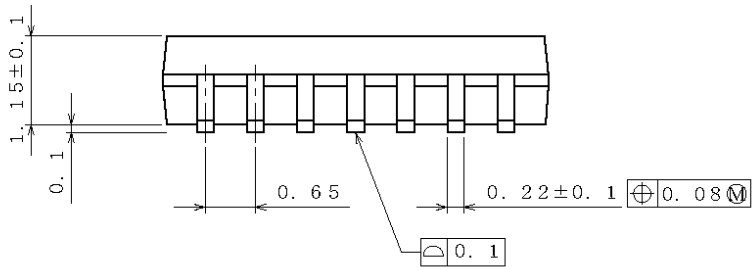
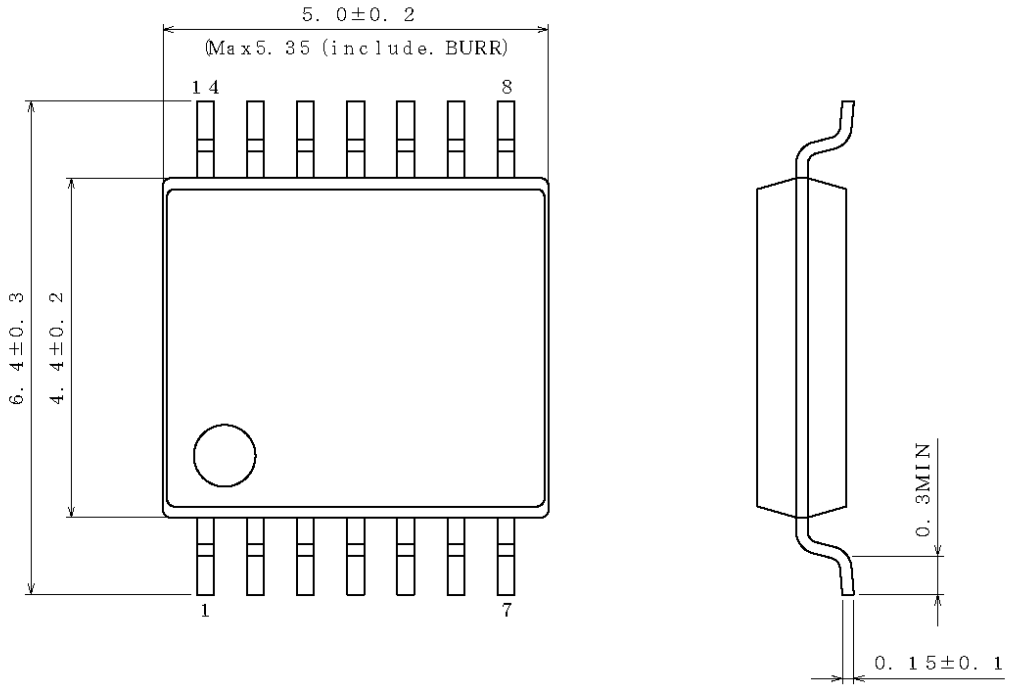

(UNIT : mm)
 PKG : SSOP-B14
 Drawing No. EX152-5002

<Tape and Reel information>

Tape	Embossed carrier tape
Quantity	2500pcs
Direction of feed	E2 (The direction is the 1pin of product is at the upper left when you hold reel on the left hand and you pull out the tape on the right hand)

Physical Dimensions, Tape and Reel Information – continued

Package Name	TSSOP-B14J
--------------	------------

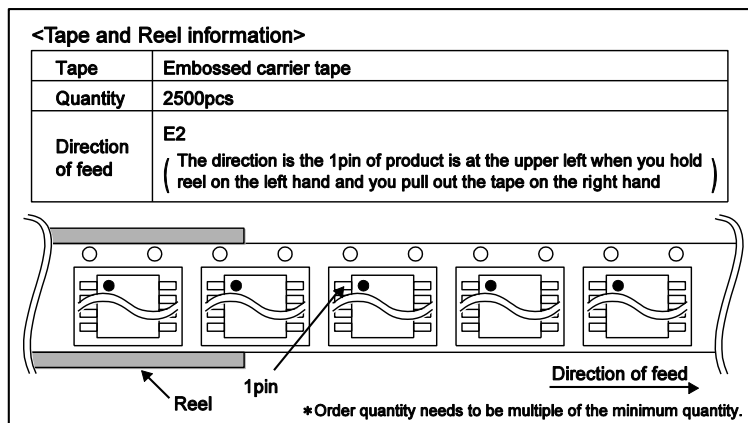
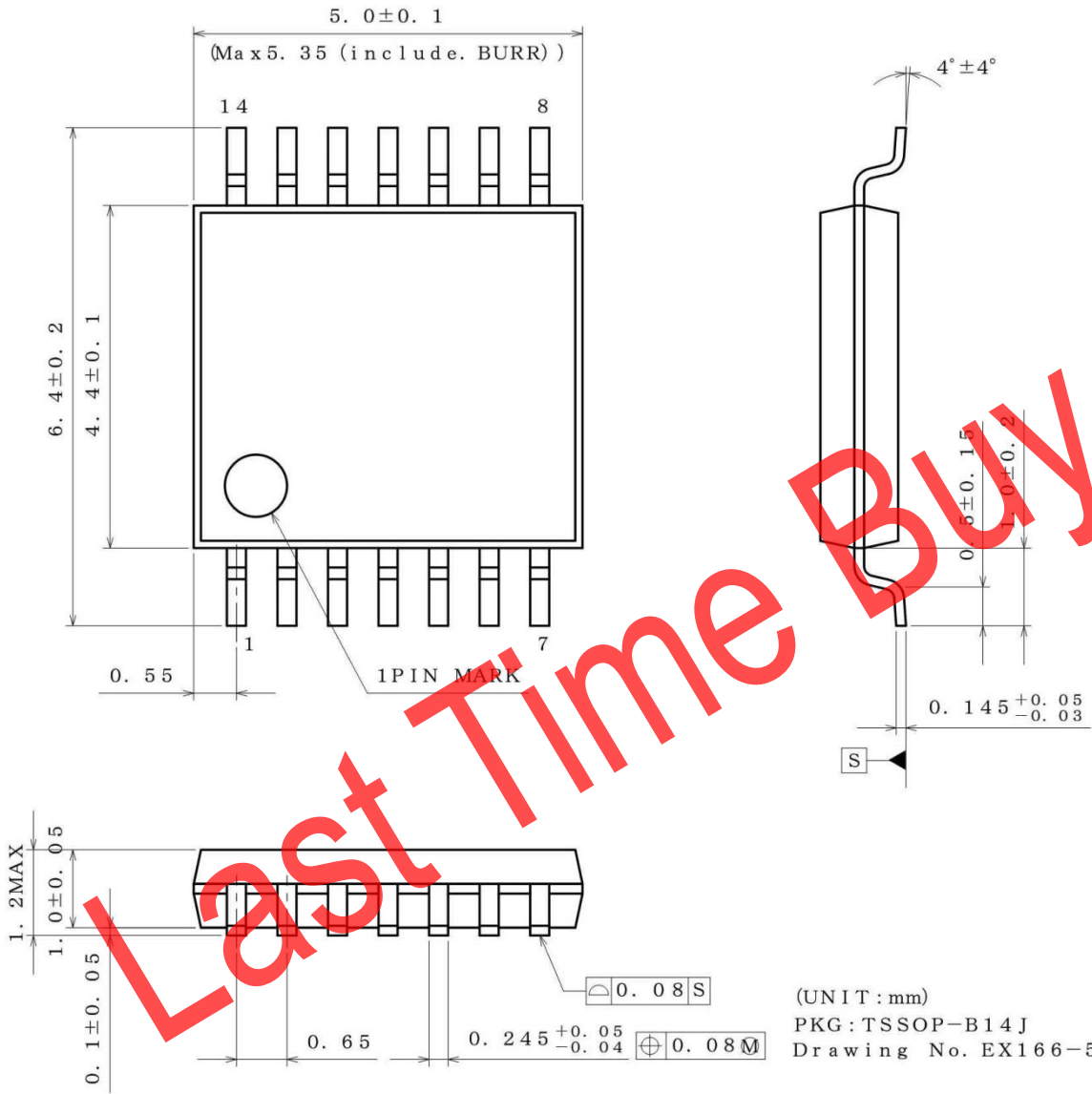

Ordering Information

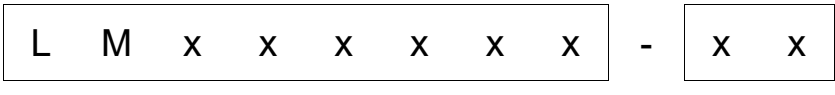

Part Number LM393F*1 LM393FJ*1 LM393FV*1 LM393FVT*1 LM393FVJ*1 LM393FVM*1 LM339F*1 LM339FJ*1 LM339FV*1 LM339FVJ*1 LM2903F*1 LM2903FJ LM2903FV*1 LM2903FVT LM2903FVJ*1 LM2903FVM LM2901F LM2901FJ*1 LM2901FV LM2901FVJ*1	Package F : SOP8*1 : SOP14*2 FJ : SOP-J8*2 : SOP-J14*1 FV : SSOP-B8*1 : SSOP-B14*2 FVT : TSSOP-B8*2 FVJ : TSSOP-B8J*1 : TSSOP-B14J*1 FVM : MSOP8*2	Packaging and forming specification E2: Embossed tape and reel (SOP8/SOP-J8/SSOP-B8/ TSSOP-B8/SOP14/SOP-J14/ SSOP-B14/TSSOP-B14J) TR: Embossed tape and reel (MSOP8)
---	--	--

*1 Last Time Buy.
 *2 Partial Last Time Buy.

Line-up

Operating Temperature Range	Channel	Package	Orderable Part Number	
-40°C to +85°C	2ch	SOP8	Reel of 2500	LM393F-E2*1
		SOP-J8	Reel of 2500	LM393FJ-E2*1
		SSOP-B8	Reel of 2500	LM393FV-E2*1
		TSSOP-B8	Reel of 3000	LM393FVT-E2*1
		TSSOP-B8J	Reel of 2500	LM393FVJ-E2*1
		MSOP8	Reel of 3000	LM393FVM-TR*1
	4ch	SOP14	Reel of 2500	LM339F-E2*1
		SOP-J14	Reel of 2500	LM339FJ-E2*1
		SSOP-B14	Reel of 2500	LM339FV-E2*1
		TSSOP-B14J	Reel of 2500	LM339FVJ-E2*1
-40°C to +125°C	2ch	SOP8	Reel of 2500	LM2903F-E2*1
		SOP-J8	Reel of 2500	LM2903FJ-E2
		SSOP-B8	Reel of 2500	LM2903FV-E2*1
		TSSOP-B8	Reel of 3000	LM2903FVT-E2
		TSSOP-B8J	Reel of 2500	LM2903FVJ-E2*1
		MSOP8	Reel of 3000	LM2903FVM-TR
	4ch	SOP14	Reel of 2500	LM2901F-E2
		SOP-J14	Reel of 2500	LM2901FJ-E2*1
		SSOP-B14	Reel of 2500	LM2901FV-E2
		TSSOP-B14J	Reel of 2500	LM2901FVJ-E2*1

*1 Last Time Buy.

Marking Diagram

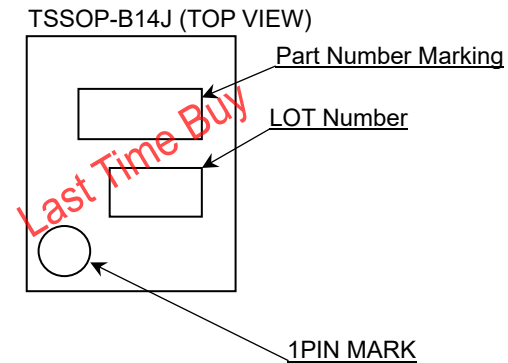
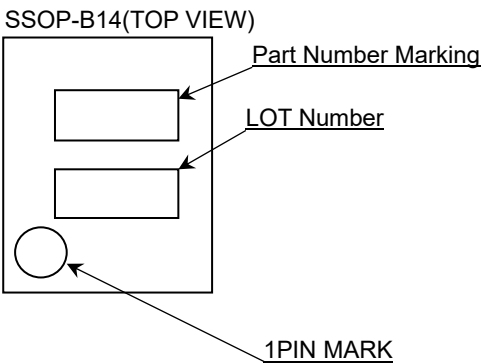
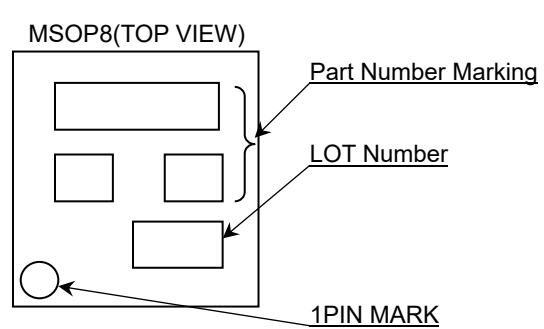
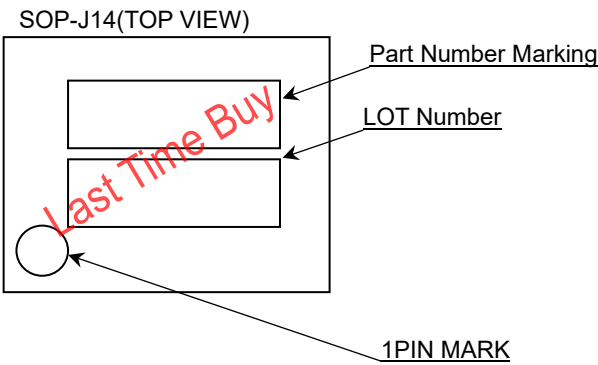
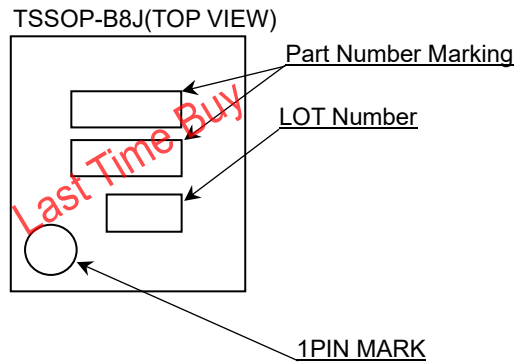
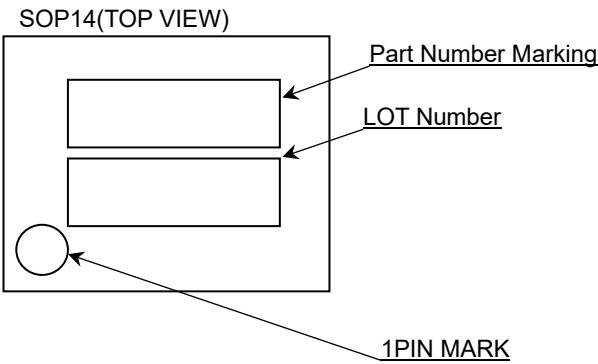
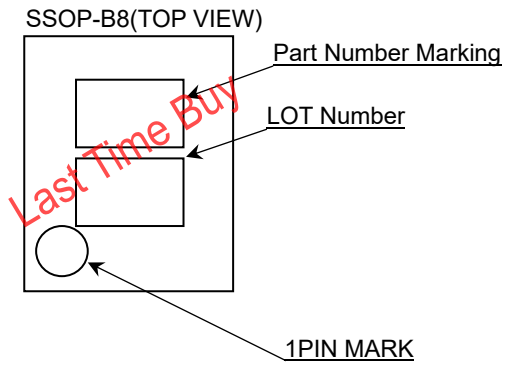
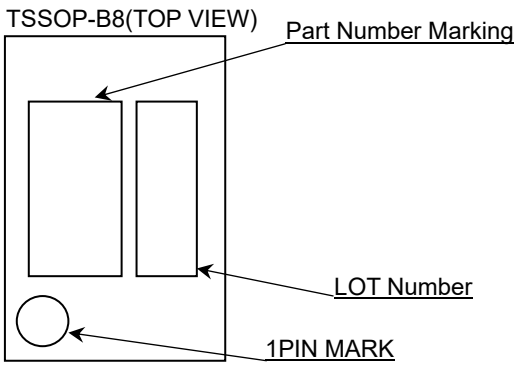
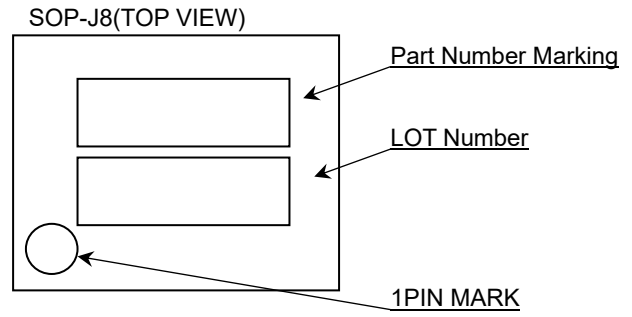
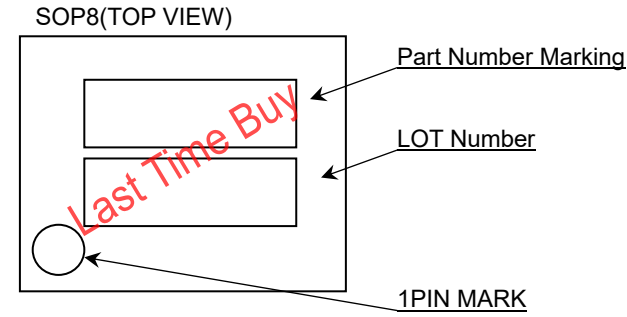

Marking Diagram – continued

Product Name		Package Type	Marking
LM393*1	F*1	SOP8	393L
	FJ*1	SOP-J8	
	FV*1	SSOP-B8	
	FVT*1	TSSOP-B8	
	FVJ*1	TSSOP-B8J	
	FVM*1	MSOP8	
LM339*1	F*1	SOP14	LM339F
	FJ*1	SOP-J14	LM339FJ
	FV*1	SSOP-B14	339L
	FVJ*1	TSSOP-B14J	
LM2903*2	F*1	SOP8	2903L
	FJ	SOP-J8	03L
	FV*1	SSOP-B8	
	FVT	TSSOP-B8	2903L
	FVJ*1	TSSOP-B8J	
	FVM	MSOP8	
LM2901*2	F	SOP14	LM2901F
	FJ*1	SOP-J14	LM2901FJ
	FV	SSOP-B14	2901L
	FVJ*1	TSSOP-B14J	

*1 Last Time Buy.

*2 Partial Last Time Buy.

Revision History

Date	Revision	Changes
8.Dec.2015	001	New Release
15.Jul.2016	002	Add LM393xxx (FJ, FV, FVT, FVM, FVJ), LM339xxx (F, FJ, FV, FVJ) LM2903xxx (F, FJ, FV, FVT, FVM, FVJ), LM2901xxx (F, FJ, FV, FVJ)
09.Dec.2025	003	Added words for Not Recommended New Designs category product.
09.Apr.2026	004	Added watermarks and words for Last Time Buy category product.

Notice

Precaution on using ROHM Products

- Our Products are designed and manufactured for application in ordinary electronic equipments (such as AV equipment, OA equipment, telecommunication equipment, home electronic appliances, amusement equipment, etc.). If you intend to use our Products in devices requiring extremely high reliability (such as medical equipment ^(Note 1), transport equipment, traffic equipment, aircraft/spacecraft, nuclear power controllers, fuel controllers, car equipment including car accessories, safety devices, etc.) and whose malfunction or failure may cause loss of human life, bodily injury or serious damage to property ("Specific Applications"), please consult with the ROHM sales representative in advance. Unless otherwise agreed in writing by ROHM in advance, ROHM shall not be in any way responsible or liable for any damages, expenses or losses incurred by you or third parties arising from the use of any ROHM's Products for Specific Applications.

(Note1) Medical Equipment Classification of the Specific Applications

JAPAN	USA	EU	CHINA
CLASS III	CLASS III	CLASS II b	CLASS III
CLASS IV		CLASS III	

- ROHM designs and manufactures its Products subject to strict quality control system. However, semiconductor products can fail or malfunction at a certain rate. Please be sure to implement, at your own responsibilities, adequate safety measures including but not limited to fail-safe design against the physical injury, damage to any property, which a failure or malfunction of our Products may cause. The following are examples of safety measures:
 - Installation of protection circuits or other protective devices to improve system safety
 - Installation of redundant circuits to reduce the impact of single or multiple circuit failure
- Our Products are designed and manufactured for use under standard conditions and not under any special or extraordinary environments or conditions, as exemplified below. Accordingly, ROHM shall not be in any way responsible or liable for any damages, expenses or losses arising from the use of any ROHM's Products under any special or extraordinary environments or conditions. If you intend to use our Products under any special or extraordinary environments or conditions (as exemplified below), your independent verification and confirmation of product performance, reliability, etc. prior to use, must be necessary:
 - Use of our Products in any types of liquid, including water, oils, chemicals, and organic solvents
 - Use of our Products outdoors or in places where the Products are exposed to direct sunlight or dust
 - Use of our Products in places where the Products are exposed to sea wind or corrosive gases, including Cl₂, H₂S, NH₃, SO₂, and NO₂
 - Use of our Products in places where the Products are exposed to static electricity or electromagnetic waves
 - Use of our Products in proximity to heat-producing components, plastic cords, or other flammable items
 - Sealing or coating our Products with resin or other coating materials
 - Use of our Products without cleaning residue of flux (Exclude cases where no-clean type fluxes is used. However, recommend sufficiently about the residue.); or Washing our Products by using water or water-soluble cleaning agents for cleaning residue after soldering
 - Use of the Products in places subject to dew condensation
- The Products are not subject to radiation-proof design.
- Please verify and confirm characteristics of the final or mounted products in using the Products.
- In particular, if a transient load (a large amount of load applied in a short period of time, such as pulse. is applied, confirmation of performance characteristics after on-board mounting is strongly recommended. Avoid applying power exceeding normal rated power; exceeding the power rating under steady-state loading condition may negatively affect product performance and reliability.
- De-rate Power Dissipation depending on ambient temperature. When used in sealed area, confirm that it is the use in the range that does not exceed the maximum junction temperature.
- Confirm that operation temperature is within the specified range described in the product specification.
- ROHM shall not be in any way responsible or liable for failure induced under deviant condition from what is defined in this document.

Precaution for Mounting / Circuit board design

- When a highly active halogenous (chlorine, bromine, etc.) flux is used, the residue of flux may negatively affect product performance and reliability.
- In principle, the reflow soldering method must be used on a surface-mount products, the flow soldering method must be used on a through hole mount products. If the flow soldering method is preferred on a surface-mount products, please consult with the ROHM representative in advance.

For details, please refer to ROHM Mounting specification

Precautions Regarding Application Examples and External Circuits

1. If change is made to the constant of an external circuit, please allow a sufficient margin considering variations of the characteristics of the Products and external components, including transient characteristics, as well as static characteristics.
2. You agree that application examples, their constants, software, and associated data and information contained in this document are presented only as guidance for Products use. Therefore, in case you use such information, you are solely responsible for it and you must exercise your own independent verification and judgment in the use of such information contained in this document. ROHM shall not be in any way responsible or liable for any damages, expenses or losses incurred by you or third parties arising from the use of such information.

Precaution for Electrostatic

This Product is electrostatic sensitive product, which may be damaged due to electrostatic discharge. Please take proper caution in your manufacturing process and storage so that voltage exceeding the Products maximum rating will not be applied to Products. Please take special care under dry condition (e.g. Grounding of human body / equipment / solder iron, isolation from charged objects, setting of Ionizer, friction prevention and temperature / humidity control).

Precaution for Storage / Transportation

1. Product performance and soldered connections may deteriorate if the Products are stored in the places where:
 - [a] the Products are exposed to sea winds or corrosive gases, including Cl₂, H₂S, NH₃, SO₂, and NO₂
 - [b] the temperature or humidity exceeds those recommended by ROHM
 - [c] the Products are exposed to direct sunshine or condensation
 - [d] the Products are exposed to high Electrostatic
2. Even under ROHM recommended storage condition, solderability of products out of recommended storage time period may be degraded. It is strongly recommended to confirm solderability before using Products of which storage time is exceeding the recommended storage time period.
3. Store / transport cartons in the correct direction, which is indicated on a carton with a symbol. Otherwise bent leads may occur due to excessive stress applied when dropping of a carton.
4. Use Products within the specified time after opening a humidity barrier bag. Baking is required before using Products of which storage time is exceeding the recommended storage time period.

Precaution for Product Label

A two-dimensional barcode printed on ROHM Products label is for ROHM's internal use only.

Precaution for Disposition

When disposing Products please dispose them properly using an authorized industry waste company.

Precaution for Foreign Exchange and Foreign Trade act

Since concerned goods might be fallen under listed items of export control prescribed by Foreign exchange and Foreign trade act, please consult with ROHM in case of export.

Precaution Regarding Intellectual Property Rights

1. All information and data including but not limited to application example contained in this document is for reference only. ROHM does not warrant that foregoing information or data will not infringe any intellectual property rights or any other rights of any third party regarding such information or data.
2. ROHM shall not have any obligations where the claims, actions or demands arising from the combination of the Products with other articles such as components, circuits, systems or external equipment (including software).
3. No license, expressly or implied, is granted hereby under any intellectual property rights or other rights of ROHM or any third parties with respect to the Products or the information contained in this document. Provided, however, that ROHM will not assert its intellectual property rights or other rights against you or your customers to the extent necessary to manufacture or sell products containing the Products, subject to the terms and conditions herein.

Other Precaution

1. This document may not be reprinted or reproduced, in whole or in part, without prior written consent of ROHM.
2. The Products may not be disassembled, converted, modified, reproduced or otherwise changed without prior written consent of ROHM.
3. In no event shall you use in any way whatsoever the Products and the related technical information contained in the Products or this document for any military purposes, including but not limited to, the development of mass-destruction weapons.
4. The proper names of companies or products described in this document are trademarks or registered trademarks of ROHM, its affiliated companies or third parties.

General Precaution

1. All information contained in this document is current as of the issuing date and subject to change without any prior notice. Before purchasing or using ROHM's Products, please confirm the latest information with a ROHM sales representative.
2. The information contained in this document is provided on an "as is" basis and ROHM does not warrant that all information contained in this document is accurate and/or error-free. ROHM shall not be in any way responsible or liable for any damages, expenses or losses incurred by you or third parties resulting from inaccuracy or errors of or concerning such information.

General Precaution

1. Before you use our Products, you are requested to carefully read this document and fully understand its contents. ROHM shall not be in any way responsible or liable for failure, malfunction or accident arising from the use of any ROHM's Products against warning, caution or note contained in this document.
2. All information contained in this document is current as of the issuing date and subject to change without any prior notice. Before purchasing or using ROHM's Products, please confirm the latest information with a ROHM sales representative.
3. The information contained in this document is provided on an "as is" basis and ROHM does not warrant that all information contained in this document is accurate and/or error-free. ROHM shall not be in any way responsible or liable for any damages, expenses or losses incurred by you or third parties resulting from inaccuracy or errors of or concerning such information.