

28V Operation High Speed Voltage Regulators with Stand-by Function

■ GENERAL DESCRIPTION

The XC6701 series are positive voltage regulator ICs manufactured using CMOS process with 28V of operation voltage. The series consists of a voltage reference, an error amplifier, a current limiter, a thermal protection circuit and a phase compensation circuit plus a driver transistor.

The output voltage is selectable in 0.1V increments within the range of 1.8V to 18V which fixed by laser trimming technologies. The output stabilization capacitor (C_L) is also compatible with low ESR ceramic capacitors.

The over current protection circuit and the thermal shutdown circuit are built-in. These two protection circuits will operate when the output current reaches current limit level or the junction temperature reaches temperature limit level.

The CE function enables the output to be turned off and the IC becomes a stand-by mode resulting in greatly reduced power consumption. Packages are selectable depending on the applications from SOT-25, SOT-89, SOT-89-5, USP-6C, SOT-223, and TO-252.

■ APPLICATIONS

- Car audio, Car navigation systems
- Note PCs / Tablet PCs
- Mobile devices / terminals
- Digital still cameras / Camcorders
- Smart phones / Mobile phones
- Multi-function power supplies

■ FEATURES

- Max Output Current** : More than 150mA (200mA limit)
($V_{IN}=V_{OUT}+3.0V$)
- Dropout Voltage** : 300mV@ $I_{OUT}=20mA$
- Input Voltage Range** : 2.0V ~ 28.0V
- Output Voltage Range** : 1.8V ~ 18.0V (0.1V increments)
- High Accuracy** : $\pm 2.0\%$
- Low Power Consumption** : 50 μA ($V_{OUT}=5.0V$)
- Stand-by Current** : 0.01 μA
- High Ripple Rejection** : 50dB@1kHz
- Operating Ambient Temperature** : -40°C ~ 85°C (XC6701B/D)
-40°C ~ 105°C (XC6701A)
- Low ESR Capacitor** : Ceramic Capacitor Compatible
(Internal Phase Compensation)
- Packages** : SOT-25, SOT-89, SOT-89-5,
USP-6C, SOT-223, TO-252
- Environmentally Friendly** : EU RoHS Compliant, Pb Free

■ TYPICAL APPLICATION CIRCUITS

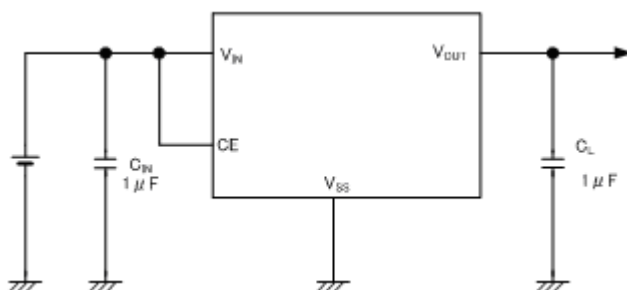

XC6701B Series
With CE function

■ TYPICAL PERFORMANCE CHARACTERISTICS

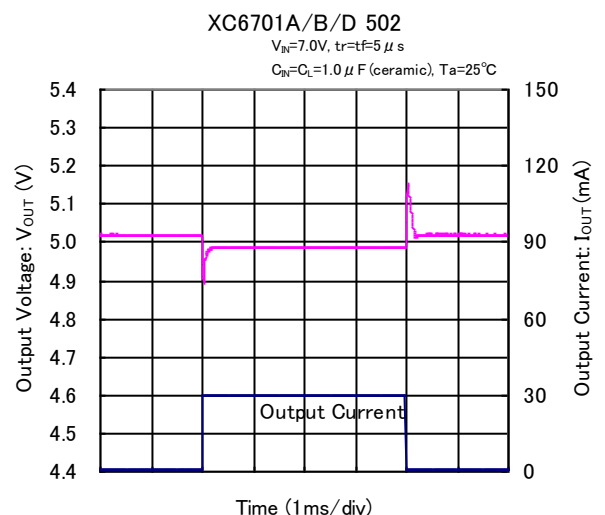

PIN CONFIGURATION

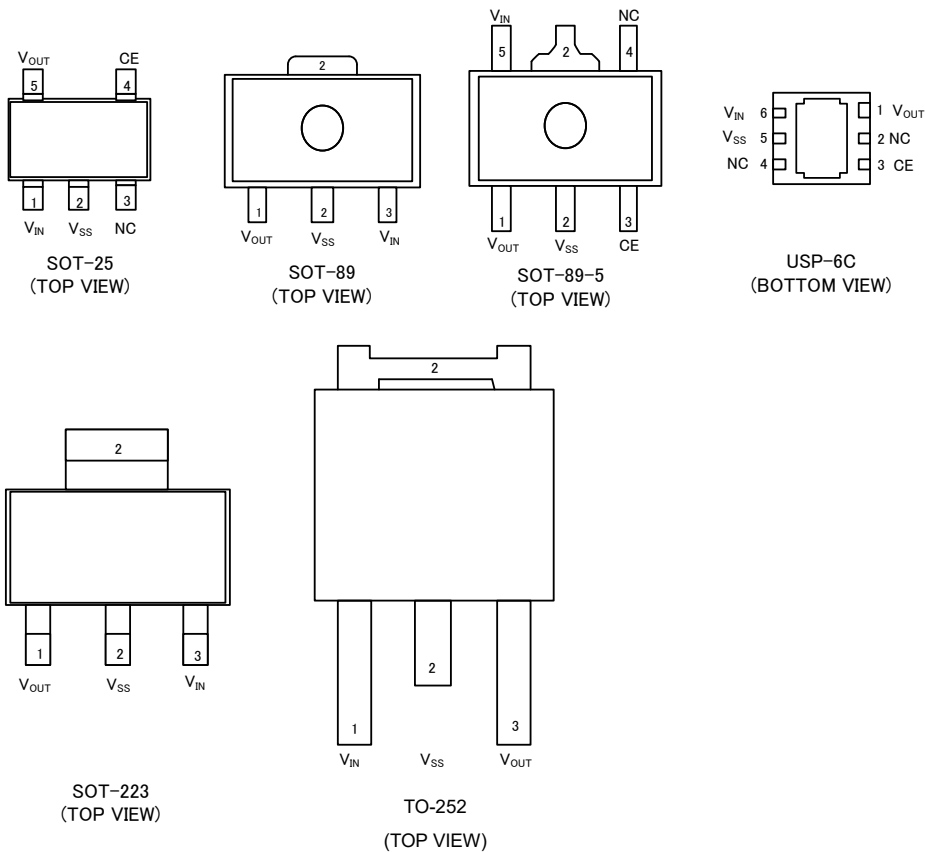

* The dissipation pad for the USP-6C package should be solder-plated in reference mount pattern and metal masking so as to enhance mounting strength and heat release. If the pad needs to be connected to other pins, it should be connected to the V_{SS} (No. 5) pin.

PIN ASSIGNMENT

●XC6701A/B Series

PIN NUMBER			PIN NAME	FUNCTIONS
SOT-25	SOT-89-5	USP-6C		
1	5	6	V_{IN}	Power Input
2	2	5	V_{SS}	Ground
3	4	2, 4	NC	No connection
4	3	3	CE	ON/OFF Control
5	1	1	V_{OUT}	Output

●XC6701D Series

PIN NUMBER			PIN NAME	FUNCTIONS
SOT-89	SOT-223	TO-252		
3	3	1	V_{IN}	Power Input
2	2	2	V_{SS}	Ground
1	1	3	V_{OUT}	Output

PIN FUNCTION ASSIGNMENT

●XC6701A/B Series

CE(Chip Enable)	IC Operation State ON/OFF
"H" Level	Operation ON
"L" Level	Operation OFF
"OPEN"	Operation Undefined

*CE pin should not be left open. Each should have a certain voltage.

■ PRODUCT CLASSIFICATION

● Ordering Information

XC6701①②③④⑤⑥-⑦^(*) : With CE function

DESIGNATOR	ITEM	SYMBOL	DESCRIPTION
①	Type	A	Fixed Output Voltage, Active High (-40°C ≤ Topr ≤ 105°C)
		B	Fixed Output Voltage, Active High (-40°C ≤ Topr ≤ 85°C)
②③	Output Voltage	18 ~ J0	For the voltage within 1.8V ~ 9.9V; e.g. 2.5V ⇒ 25 5.0V ⇒ 50 For the voltage above 10.0V; For 10V, 11V, 12V, 13V, 14V, 15V, 16V, 17V and 18V units, use A, B, C, D, E, F, G, H and J for "②". e.g. 11.6V ⇒ B6 15.2V ⇒ F2 18.0V ⇒ J0
④	Output Voltage Accuracy	2	±2.0% accuracy
⑤⑥-⑦ ^(*)	Packages (Order Unit)	MR-G	SOT-25 (3,000pcs/Reel)
		PR-G	SOT-89-5 (1,000pcs/Reel)
		ER-G	USP-6C (3,000pcs/Reel)

^(*) The "-G" suffix denotes Halogen and Antimony free as well as being fully EU RoHS compliant.

XC6701①②③④⑤⑥-⑦^(*) : Without CE function

DESIGNATOR	ITEM	SYMBOL	DESCRIPTION
①	Type	D	Fixed Output Voltage, No CE function (-40°C ≤ Topr ≤ 85°C)
②③	Output Voltage	18 ~ J0	For the voltage within 1.8V ~ 9.9V; e.g. 2.5V ⇒ 25 5.0V ⇒ 50 For the voltage above 10.0V; For 10V, 11V, 12V, 13V, 14V, 15V, 16V, 17V and 18V units, use A, B, C, D, E, F, G, H and J for "②". e.g. 11.6V ⇒ B6 15.2V ⇒ F2 18.0V ⇒ J0
④	Output Voltage Accuracy	2	±2.0% accuracy
⑤⑥-⑦ ^(*)	Packages (Order Unit)	FR-G	SOT-223 (1,000pcs/Reel)
		JR-G	TO-252 (2,500pcs/Reel)
		PR-G	SOT-89 (1,000pcs/Reel)

^(*) The "-G" suffix denotes Halogen and Antimony free as well as being fully EU RoHS compliant.

■ BLOCK DIAGRAMS

●XC6701A/B Series
(SOT-25, SOT-89-5, USP-6C)

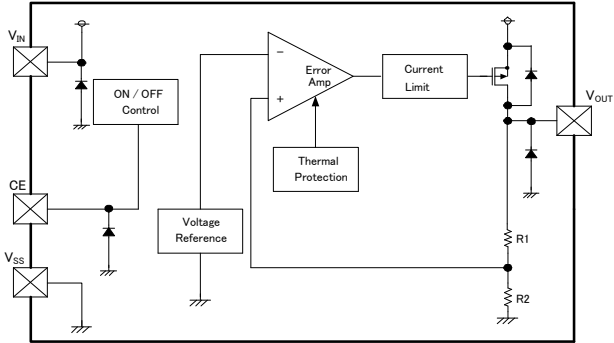

●XC6701D Series
(SOT-89, SOT-223, TO-252)

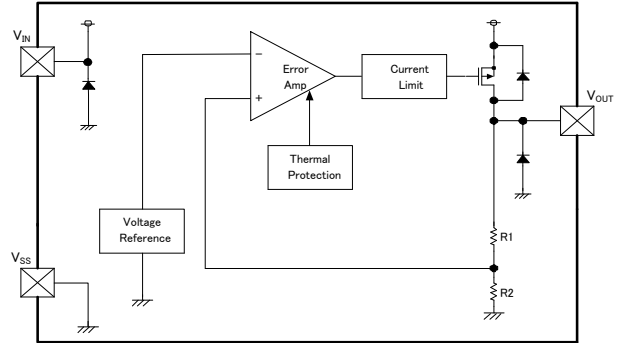

■ ABSOLUTE MAXIMUM RATINGS

● XC6701A Series

Ta=25°C

PARAMETER		SYMBOL	RATINGS	UNIT
Input Voltage		V _{IN}	V _{SS} - 0.3 ~ 30	V
Output Current		I _{OUT}	300 (*1)	mA
Output Voltage		V _{OUT}	V _{SS} - 0.3 ~ V _{IN} + 0.3	V
CE Input Voltage		V _{CE}	V _{SS} - 0.3 ~ 30	V
Power Dissipation	SOT-25	Pd	250 (IC only)	mW
			600 (40mm x 40mm Standard board) (*2)	
	SOT-89-5		500 (IC only)	
			1300 (40mm x 40mm Standard board) (*2)	
	USP-6C		120 (IC only)	
1000 (40mm x 40mm Standard board) (*2)				
Operating Ambient Temperature		Topr	-40 ~ 105	°C
Storage Temperature		Tstg	-55 ~ 125	°C

*1: $I_{OUT} \leq Pd / (V_{IN} - V_{OUT})$

*2: Please refer to PACKAGING INFORMATION for the mounting condition.

● XC6701B Series

Ta=25°C

PARAMETER		SYMBOL	RATINGS	UNIT
Input Voltage		V _{IN}	V _{SS} - 0.3 ~ 30	V
Output Current		I _{OUT}	300 (*1)	mA
Output Voltage		V _{OUT}	V _{SS} - 0.3 ~ V _{IN} +0.3	V
CE Input Voltage		V _{CE}	V _{SS} - 0.3 ~ 30	V
Power Dissipation	SOT-25	Pd	250 (IC only)	mW
			600 (40mm x 40mm Standard board) (*2)	
	SOT-89-5		500 (IC only)	
			1300 (40mm x 40mm Standard board) (*2)	
	USP-6C		120 (IC only)	
1000 (40mm x 40mm Standard board) (*2)				
Operating Ambient Temperature		Topr	-40 ~ 85	°C
Storage Temperature		Tstg	-55 ~ 125	°C

*1: $I_{OUT} \leq Pd / (V_{IN} - V_{OUT})$

*2: Please refer to PACKAGING INFORMATION for the mounting condition.

● XC6701D Series

Ta=25°C

PARAMETER		SYMBOL	RATINGS	UNIT
Input Voltage		V _{IN}	V _{SS} - 0.3 ~ 30	V
Output Current		I _{OUT}	300 (*1)	mA
Output Voltage		V _{OUT}	V _{SS} - 0.3 ~ V _{IN} + 0.3	V
Power Dissipation	SOT-89	Pd	500 (IC only)	mW
			1000 (40mm x 40mm Standard board) (*2)	
	SOT-223		300 (IC only)	
			1500 (40mm x 40mm Standard board) (*2)	
	TO-252		500 (IC only)	
1800 (40mm x 40mm Standard board) (*2)				
Operating Ambient Temperature		Topr	-40 ~ 85	°C
Storage Temperature		Tstg	-55 ~ 125	°C

*1: $I_{OUT} \leq Pd / (V_{IN} - V_{OUT})$

*2: Please refer to PACKAGING INFORMATION for the mounting condition.

ELECTRICAL CHARACTERISTICS

●XC6701A/Bxx2 Series

Ta=25°C

PARAMETER	SYMBOL	CONDITIONS	MIN.	TYP.	MAX.	UNIT	CIRCUIT	
Output Voltage	$V_{OUT(E)}$	$I_{OUT}=10mA, V_{CE}=V_{IN}$	E2-0			V	①	
Maximum Output Current	I_{OUTMAX}	$V_{IN}=V_{OUT(T)}+3.0V, V_{CE}=V_{IN}$ ($V_{OUT(T)} \geq 3.0V$)	150	-	-	mA	①	
		$V_{IN}=V_{OUT(T)}+3.0V, V_{CE}=V_{IN}$ ($V_{OUT(T)} < 3.0V$)	100	-	-	mA	①	
Load Regulation	ΔV_{OUT}	$1mA \leq I_{OUT} \leq 50mA, V_{CE}=V_{IN}$ $1.8V \leq V_{OUT(T)} \leq 5.0V$	-	50	90	mV	①	
		$1mA \leq I_{OUT} \leq 50mA, V_{CE}=V_{IN}$ $5.1V \leq V_{OUT(T)} \leq 12.0V$	-	110	175			
		$1mA \leq I_{OUT} \leq 50mA, V_{CE}=V_{IN}$ $12.1V \leq V_{OUT(T)} \leq 18.0V$	-	180	275			
Dropout Voltage 1	V_{dif1}	$I_{OUT}=20mA, V_{CE}=V_{IN}$	E2-1			mV	①	
Dropout Voltage 2	V_{dif2}	$I_{OUT}=100mA, V_{CE}=V_{IN}$	E2-2			mV	①	
Supply Current	I_{SS}	$1.8V \leq V_{OUT(T)} \leq 5.0V$	11	50	105	μA	②	
		$5.1V \leq V_{OUT(T)} \leq 12.0V$	11	60	115			
		$12.1V \leq V_{OUT(T)} \leq 18.0V$	11	65	125			
Stand-by Current	I_{STB}	$V_{CE}=V_{SS}$	-	0.01	0.10	μA	②	
Line Regulation 1	$\frac{\Delta V_{OUT}}{(\Delta V_{IN} \cdot V_{OUT})}$	$V_{OUT(T)}+2.0V \leq V_{IN} \leq 28.0V$ $I_{OUT}=5mA, V_{CE}=V_{IN}$	-	0.05	0.10	%/V	①	
Line Regulation 2	$\frac{\Delta V_{OUT}}{(\Delta V_{IN} \cdot V_{OUT})}$	$V_{OUT(T)}+2.0V \leq V_{IN} \leq 28.0V$ $I_{OUT}=13mA, V_{CE}=V_{IN}$	-	0.15	0.30	%/V	①	
Input Voltage	V_{IN}		2.0	-	28.0	V	-	
Output Voltage Temperature Characteristics	$\frac{\Delta V_{OUT}}{(\Delta Ta \cdot V_{OUT})}$	$I_{OUT}=20mA, V_{CE}=V_{IN}$	XC6701A - $40^\circ C \leq Ta \leq 105^\circ C$	-	± 100	-	ppm/°C	①
			XC6701B - $40^\circ C \leq Ta \leq 85^\circ C$					
Power Supply Rejection Ratio	PSRR	$V_{IN}=[V_{OUT(T)}+2.0V]V_{DC}+0.5V_{P-PAC}$ $I_{OUT}=20mA, f=1kHz, V_{CE}=V_{IN}$	-	50	-	dB	③	
Short Current	I_{SHORT}	$V_{IN}=V_{OUT(T)}+2.0V, V_{CE}=V_{IN}$	-	40	-	mA	①	
CE "H" Voltage	V_{CEH}	$V_{IN}=28.0V$	1.1	-	28.0	V	①	
CE "L" Voltage	V_{CEL}	$V_{IN}=28.0V$	0	-	0.35	V	①	
CE "H" Current	I_{CEH}	$V_{IN}=V_{CE}=28.0V$	-0.1	-	0.1	μA	①	
CE "L" Current	I_{CEL}	$V_{IN}=28.0V, V_{CE}=V_{SS}$	-0.1	-	0.1	μA	①	
Thermal Shutdown Detect Temperature	T_{TSD}	Junction Temperature	-	150	-	°C	①	
Thermal Shutdown Release Temperature	T_{TSR}	Junction Temperature	-	125	-	°C	①	
Hysteresis Width	$T_{TSD}-T_{TSR}$	Junction Temperature	-	25	-	°C	-	

NOTE:

*1: $V_{OUT(T)}$: Nominal output voltage

*2: $V_{OUT(E)}$: Effective output voltage

(i.e. the output voltage when " $V_{OUT(T)}+2.0V$ " is provided at the V_{IN} pin while maintaining a certain I_{OUT} value.)

*3: $V_{dif}=\{V_{IN1}^{(Note 5)} - V_{OUT1}^{(Note 4)}\}$

*4: V_{OUT1} : In case of $V_{OUT(T)} < 3.0V$, the V_{OUT1} is equal to 98% of the $V_{OUT(T)}$ when a stabilized input voltage is applied in $V_{OUT(T)}+3.0V$.
: In case of $V_{OUT(T)} \geq 3.0V$, the V_{OUT1} is equal to 98% of the $V_{OUT(T)}$ when a stabilized input voltage is applied in $V_{OUT(T)}+2.0V$.

*5: V_{IN1} : The input voltage when V_{OUT1} appears as input voltage is gradually decreased.

*6: Unless otherwise stated, $V_{IN}=V_{OUT(T)}+2.0V$.

■ ELECTRICAL CHARACTERISTICS

● XC6701Dxx2 Series

Ta=25°C

PARAMETER	SYMBOL	CONDITIONS	MIN.	TYP.	MAX.	UNIT	CIRCUIT
Output Voltage	$V_{OUT(E)}$	$I_{OUT}=10\text{mA}$	E2-0			V	①
Maximum Output Current	I_{OUTMAX}	$V_{IN}=V_{OUT(T)}+3.0\text{V}$ ($V_{OUT(T)}\geq 3.0\text{V}$)	150	-	-	mA	①
		$V_{IN}=V_{OUT(T)}+3.0\text{V}$ ($V_{OUT(T)}< 3.0\text{V}$)	100	-	-	mA	①
Load Regulation	ΔV_{OUT}	$1\text{mA}\leq I_{OUT}\leq 50\text{mA}$ $1.8\text{V}\leq V_{OUT(T)}\leq 5.0\text{V}$	-	50	90	mV	①
		$1\text{mA}\leq I_{OUT}\leq 50\text{mA}$ $5.1\text{V}\leq V_{OUT(T)}\leq 12.0\text{V}$	-	110	175		
		$1\text{mA}\leq I_{OUT}\leq 50\text{mA}$ $12.1\text{V}\leq V_{OUT(T)}\leq 18.0\text{V}$	-	180	275		
Dropout Voltage1	V_{dif1}	$I_{OUT}=20\text{mA}$	E2-1			mV	①
Dropout Voltage2	V_{dif2}	$I_{OUT}=100\text{mA}$	E2-2			mV	①
Supply Current	I_{SS}	$1.8\text{V}\leq V_{OUT(T)}\leq 5.0\text{V}$	11	50	105	μA	②
		$5.1\text{V}\leq V_{OUT(T)}\leq 12.0\text{V}$	11	60	115		
		$12.1\text{V}\leq V_{OUT(T)}\leq 18.0\text{V}$	11	65	125		
Line Regulation1	$\frac{\Delta V_{OUT}}{(\Delta V_{IN} \cdot V_{OUT})}$	$V_{OUT(T)}+2.0\text{V}\leq V_{IN}\leq 28.0\text{V}$ $I_{OUT}=5\text{mA}$	-	0.05	0.10	%/V	①
Line Regulation2	$\frac{\Delta V_{OUT}}{(\Delta V_{IN} \cdot V_{OUT})}$	$V_{OUT(T)}+2.0\text{V}\leq V_{IN}\leq 28.0\text{V}$ $I_{OUT}=13\text{mA}$	-	0.15	0.30	%/V	①
Input Voltage	V_{IN}		2.0	-	28.0	V	-
Output Voltage Temperature Characteristics	$\frac{\Delta V_{OUT}}{(\Delta T_a \cdot V_{OUT})}$	$I_{OUT}=20\text{mA}$ $-40^\circ\text{C}\leq T_a\leq 85^\circ\text{C}$	-	± 100	-	ppm/°C	①
Power Supply Rejection Ratio	PSRR	$V_{IN}=[V_{OUT(T)}+2.0\text{V}]+0.5V_{P-PAC}$ $I_{OUT}=20\text{mA}$, $f=1\text{kHz}$	-	50	-	dB	③
Short Current	I_{SHORT}	$V_{IN}=V_{OUT(T)}+2.0\text{V}$	-	40	-	mA	①
Thermal Shutdown Detect Temperature	T_{TSD}	Junction Temperature	-	150	-	°C	①
Thermal Shutdown Release Temperature	T_{TSR}	Junction Temperature	-	125	-	°C	①
Hysteresis Width	$T_{TSD}-T_{TSR}$	Junction Temperature	-	25	-	°C	-

ELECTRICAL CHARACTERISTICS

● Voltage Chart

SYMBOL	E2-0		E2-1		E2-2	
PARAMETER	OUTPUT VOLTAGE(V) (2% products)		DROPOUT VOLTAGE 1 (mV) $I_{OUT}=20mA$		DROPOUT VOLTAGE 2 (mV) $I_{OUT}=100mA$	
NOMINAL OUTPUT VOLTAGE (V)	V_{OUT}		V_{dif1}		V_{dif2}	
$V_{OUT(T)}$ (V)	MIN.	MAX.	TYP.	MAX.	TYP.	MAX.
1.8	1.764	1.836	550	710	2200	2700
1.9	1.862	1.938	550	710	2200	2700
2.0	1.960	2.040	450	600	1900	2600
2.1	2.058	2.142	450	600	1900	2600
2.2	2.156	2.244	390	520	1700	2200
2.3	2.254	2.346	390	520	1700	2200
2.4	2.352	2.448	390	520	1700	2200
2.5	2.450	2.550	310	450	1500	1900
2.6	2.548	2.652	310	450	1500	1900
2.7	2.646	2.754	310	450	1500	1900
2.8	2.744	2.856	310	450	1500	1900
2.9	2.842	2.958	310	450	1500	1900
3.0	2.940	3.060	260	360	1300	1700
3.1	3.038	3.162	260	360	1300	1700
3.2	3.136	3.264	260	360	1300	1700
3.3	3.234	3.366	260	360	1300	1700
3.4	3.332	3.468	260	360	1300	1700
3.5	3.430	3.570	260	360	1300	1700
3.6	3.528	3.672	260	360	1300	1700
3.7	3.626	3.774	260	360	1300	1700
3.8	3.724	3.876	260	360	1300	1700
3.9	3.822	3.978	260	360	1300	1700
4.0	3.920	4.080	220	320	1100	1500
4.1	4.018	4.182	220	320	1100	1500
4.2	4.116	4.284	220	320	1100	1500
4.3	4.214	4.386	220	320	1100	1500
4.4	4.312	4.488	220	320	1100	1500
4.5	4.410	4.590	220	320	1100	1500
4.6	4.508	4.692	220	320	1100	1500
4.7	4.606	4.794	220	320	1100	1500
4.8	4.704	4.896	220	320	1100	1500
4.9	4.802	4.998	220	320	1100	1500
5.0	4.900	5.100	190	280	1000	1300
5.1	4.998	5.202	190	280	1000	1300
5.2	5.096	5.304	190	280	1000	1300
5.3	5.194	5.406	190	280	1000	1300
5.4	5.292	5.508	190	280	1000	1300
5.5	5.390	5.610	190	280	1000	1300
5.6	5.488	5.712	190	280	1000	1300
5.7	5.586	5.814	190	280	1000	1300
5.8	5.684	5.916	190	280	1000	1300
5.9	5.782	6.018	190	280	1000	1300
6.0	5.880	6.120	190	280	1000	1300

■ ELECTRICAL CHARACTERISTICS

● Voltage Chart (Continued)

SYMBOL	E2-0		E2-1		E2-2	
PARAMETER	OUTPUT VOLTAGE(V) (2% products)		DROPOUT VOLTAGE 1 (mV) $I_{OUT}=20mA$		DROPOUT VOLTAGE 2 (mV) $I_{OUT}=100mA$	
NOMINAL OUTPUT VOLTAGE (V)	V_{OUT}		V_{dif1}		V_{dif2}	
$V_{OUT(T)}$ (V)	MIN.	MAX.	TYP.	MAX.	TYP.	MAX.
6.1	5.978	6.222	190	280	1000	1300
6.2	6.076	6.324	190	280	1000	1300
6.3	6.174	6.426	190	280	1000	1300
6.4	6.272	6.528	190	280	1000	1300
6.5	6.370	6.630	170	230	800	1150
6.6	6.468	6.732	170	230	800	1150
6.7	6.566	6.834	170	230	800	1150
6.8	6.664	6.936	170	230	800	1150
6.9	6.762	7.038	170	230	800	1150
7.0	6.860	7.140	170	230	800	1150
7.1	6.958	7.242	170	230	800	1150
7.2	7.056	7.344	170	230	800	1150
7.3	7.154	7.446	170	230	800	1150
7.4	7.252	7.548	170	230	800	1150
7.5	7.350	7.650	170	230	800	1150
7.6	7.448	7.752	170	230	800	1150
7.7	7.546	7.854	170	230	800	1150
7.8	7.644	7.956	170	230	800	1150
7.9	7.742	8.058	170	230	800	1150
8.0	7.840	8.160	170	230	800	1150
8.1	7.938	8.262	130	190	700	950
8.2	8.036	8.364	130	190	700	950
8.3	8.134	8.466	130	190	700	950
8.4	8.232	8.568	130	190	700	950
8.5	8.330	8.670	130	190	700	950
8.6	8.428	8.772	130	190	700	950
8.7	8.526	8.874	130	190	700	950
8.8	8.624	8.976	130	190	700	950
8.9	8.722	9.078	130	190	700	950
9.0	8.820	9.180	130	190	700	950
9.1	8.918	9.282	130	190	700	950
9.2	9.016	9.384	130	190	700	950
9.3	9.114	9.486	130	190	700	950
9.4	9.212	9.588	130	190	700	950
9.5	9.310	9.690	130	190	700	950
9.6	9.408	9.792	130	190	700	950
9.7	9.506	9.894	130	190	700	950
9.8	9.604	9.996	130	190	700	950
9.9	9.702	10.098	130	190	700	950
10.0	9.800	10.200	130	190	700	950

ELECTRICAL CHARACTERISTICS

● Voltage Chart (Continued)

SYMBOL	E2-0		E2-1		E2-2	
PARAMETER	OUTPUT VOLTAGE(V) (2% products)		DROPOUT VOLTAGE 1 (mV) $I_{OUT}=20mA$		DROPOUT VOLTAGE 2 (mV) $I_{OUT}=100mA$	
NOMINAL OUTPUT VOLTAGE (V)	V_{OUT}		V_{dif1}		V_{dif2}	
$V_{OUT(T)}$ (V)	MIN.	MAX.	TYP.	MAX.	TYP.	MAX.
10.1	9.898	10.302	120	170	650	850
10.2	9.996	10.404	120	170	650	850
10.3	10.094	10.506	120	170	650	850
10.4	10.192	10.608	120	170	650	850
10.5	10.290	10.710	120	170	650	850
10.6	10.388	10.812	120	170	650	850
10.7	10.486	10.914	120	170	650	850
10.8	10.584	11.016	120	170	650	850
10.9	10.682	11.118	120	170	650	850
11.0	10.780	11.220	120	170	650	850
11.1	10.878	11.322	120	170	650	850
11.2	10.976	11.424	120	170	650	850
11.3	11.074	11.526	120	170	650	850
11.4	11.172	11.628	120	170	650	850
11.5	11.270	11.730	120	170	650	850
11.6	11.368	11.832	120	170	650	850
11.7	11.466	11.934	120	170	650	850
11.8	11.564	12.036	120	170	650	850
11.9	11.662	12.138	120	170	650	850
12.0	11.760	12.240	120	170	650	850
12.1	11.858	12.342	120	170	650	850
12.2	11.956	12.444	120	170	650	850
12.3	12.054	12.546	120	170	650	850
12.4	12.152	12.648	120	170	650	850
12.5	12.250	12.750	120	170	650	850
12.6	12.348	12.852	120	170	650	850
12.7	12.446	12.954	120	170	650	850
12.8	12.544	13.056	120	170	650	850
12.9	12.642	13.158	120	170	650	850
13.0	12.740	13.260	120	170	650	850
13.1	12.838	13.362	120	170	650	850
13.2	12.936	13.464	120	170	650	850
13.3	13.034	13.566	120	170	650	850
13.4	13.132	13.668	120	170	650	850
13.5	13.230	13.770	120	170	650	850
13.6	13.328	13.872	120	170	650	850
13.7	13.426	13.974	120	170	650	850
13.8	13.524	14.076	120	170	650	850
13.9	13.622	14.178	120	170	650	850
14.0	13.720	14.280	120	170	650	850

■ ELECTRICAL CHARACTERISTICS

● Voltage Chart (Continued)

SYMBOL PARAMETER NOMINAL OUTPUT VOLTAGE (V)	E2-0		E2-1		E2-2	
	OUTPUT VOLTAGE(V) (2% products)		DROPOUT VOLTAGE 1 (mV) $I_{OUT}=20mA$		DROPOUT VOLTAGE 2 (mV) $I_{OUT}=100mA$	
	$V_{OUT(T)}$ (V)	V_{OUT}		V_{dif1}		V_{dif2}
	MIN.	MAX.	TYP.	MAX.	TYP.	MAX.
14.1	13.818	14.382	120	170	650	850
14.2	13.916	14.484	120	170	650	850
14.3	14.014	14.586	120	170	650	850
14.4	14.112	14.688	120	170	650	850
14.5	14.210	14.790	120	170	650	850
14.6	14.308	14.892	120	170	650	850
14.7	14.406	14.994	120	170	650	850
14.8	14.504	15.096	120	170	650	850
14.9	14.602	15.198	120	170	650	850
15.0	14.700	15.300	120	170	650	850
15.1	14.798	15.402	120	170	650	850
15.2	14.896	15.504	120	170	650	850
15.3	14.994	15.606	120	170	650	850
15.4	15.092	15.708	120	170	650	850
15.5	15.190	15.810	120	170	650	850
15.6	15.288	15.912	120	170	650	850
15.7	15.386	16.014	120	170	650	850
15.8	15.484	16.116	120	170	650	850
15.9	15.582	16.218	120	170	650	850
16.0	15.680	16.320	120	170	650	850
16.1	15.778	16.422	120	170	650	850
16.2	15.876	16.524	120	170	650	850
16.3	15.974	16.626	120	170	650	850
16.4	16.072	16.728	120	170	650	850
16.5	16.170	16.830	120	170	650	850
16.6	16.268	16.932	120	170	650	850
16.7	16.366	17.034	120	170	650	850
16.8	16.464	17.136	120	170	650	850
16.9	16.562	17.238	120	170	650	850
17.0	16.660	17.340	120	170	650	850
17.1	16.758	17.442	120	170	650	850
17.2	16.856	17.544	120	170	650	850
17.3	16.954	17.646	120	170	650	850
17.4	17.052	17.748	120	170	650	850
17.5	17.150	17.850	120	170	650	850
17.6	17.248	17.952	120	170	650	850
17.7	17.346	18.054	120	170	650	850
17.8	17.444	18.156	120	170	650	850
17.9	17.542	18.258	120	170	650	850
18.0	17.640	18.360	120	170	650	850

OPERATIONAL EXPLANATION

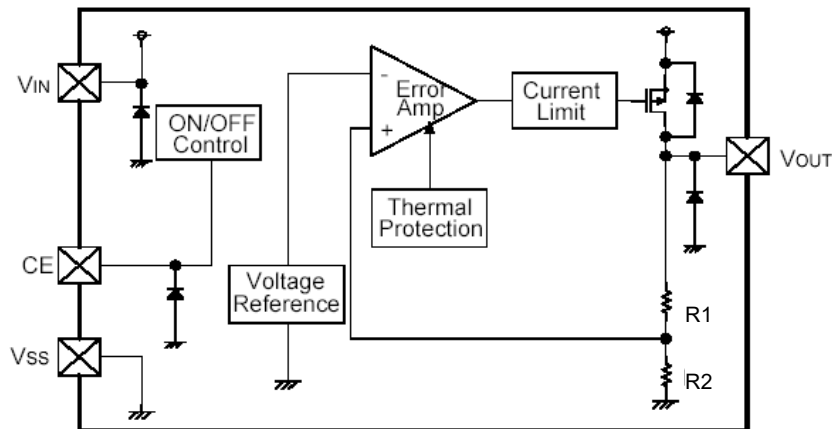

<Output Voltage Control>

The voltage divided by resistors R1 & R2 is compared with the internal reference voltage by the error amplifier. The P-channel MOSFET, which is connected to the V_{OUT} pin, is then driven by the subsequent output signal. The output voltage at the V_{OUT} pin is controlled and stabilized by a system of negative feedback. The current limit circuit, short protect circuit and thermal protection circuit operate in relation to the level of output current and heat generation. Further, the IC's internal circuitry can be shutdown via the CE pin's signal.

<Short-Circuit Protection>

The XC6701 series includes a current fold-back circuit as a short circuit protection. When the load current reaches the current limit level, the current fold-back circuit operates and output voltage drops. The output voltage drops further and output current decreases. When the output pin is shorted, a current of about 30mA flows.

<CE Pin>

The IC's internal circuitry can be shutdown via the signal from the CE pin with the XC6701A/B series. In shutdown mode, output at the V_{OUT} pin will be pulled down by R1 and R2 to the V_{SS} level. Note that as the XC6701B series' operations will become unstable with the CE pin open. We suggest that you use this IC with either a V_{IN} voltage or a V_{SS} voltage input at the CE pin. If this IC is used with the correct specifications for the CE pin, the operational logic is fixed and the IC will operate normally. However, supply current may increase as a result of through current in the IC's internal circuitry if a medium voltage is applied.

<Thermal Shutdown>

When the junction temperature of the built-in driver transistor reaches the temperature limit level (150°C TYP.), the thermal protection circuit operates and the driver transistor will be set to OFF. The IC resumes its operation when the thermal shutdown function is released and the IC's operation is automatically restored because the junction temperature drops to the level of the thermal shutdown release voltage.

<Minimum Operating Voltage>

For the stable operation of the IC, over 2.0V of input voltage is necessary. The output voltage may not be generated normally if the input voltage is less than 2.0V.

NOTES ON USE

1. For temporary, transitional voltage drop or voltage rising phenomenon, the IC is liable to malfunction should the ratings be exceeded.
2. Where wiring impedance is high, operations may become unstable due to the noise and/or phase lag depending on output current. Please strengthen V_{IN} and V_{SS} wiring in particular.
3. Phase compensation inside the IC is performed in the XC6701 series. Therefore, an abnormal oscillation does not occur even if there is no output capacitor C_L . An input capacitor C_{IN} around $0.1 \mu F \sim 1.0 \mu F$ between the V_{IN} pin and the V_{SS} pin is required for input stability. Also, the output voltage fluctuation such as under shoot or over shoot, which occurs because of the load change can be controlled by placing the output capacitor C_L around $0.1 \mu F \sim 1.0 \mu F$ between the V_{OUT} pin and V_{SS} pin. The input capacitor (C_{IN}) and the output capacitor (C_L) should be placed to the IC as close as possible with a shorter wiring.
4. When the IC is operated with no load, the output voltage may increase in the high temperature beyond operating range.
5. Torex places an importance on improving our products and its reliability.
However, by any possibility, we would request user fail-safe design and post-aging treatment on system or equipment.

TEST CIRCUITS

Circuit ①

●XC6701A/B Series

●XC6701D Series

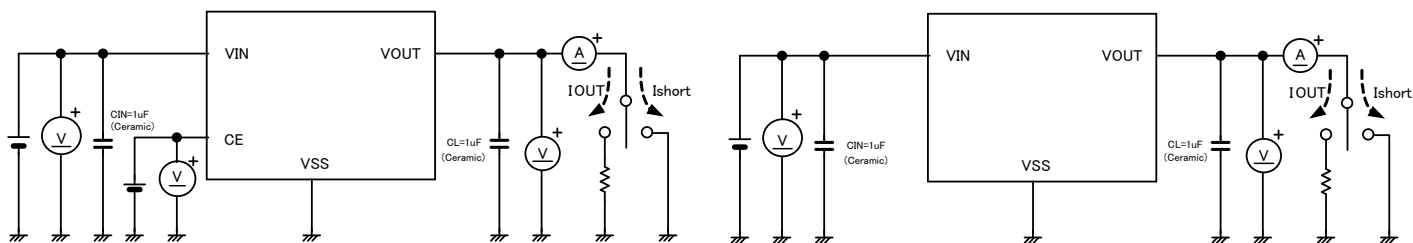

Circuit ②

●XC6701A/B Series

●XC6701D Series

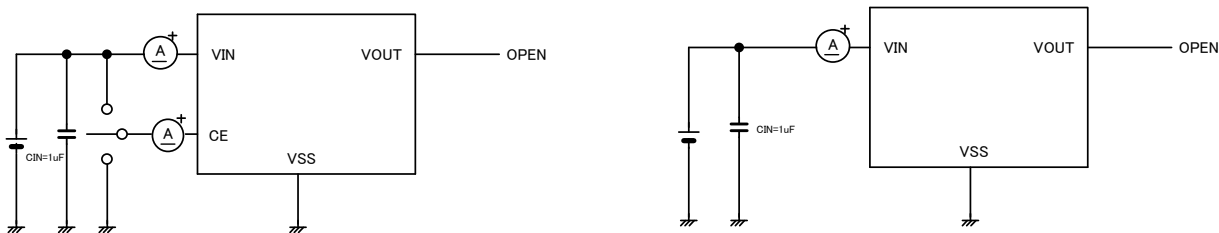

Circuit ③

●XC6701A/B Series

●XC6701D Series

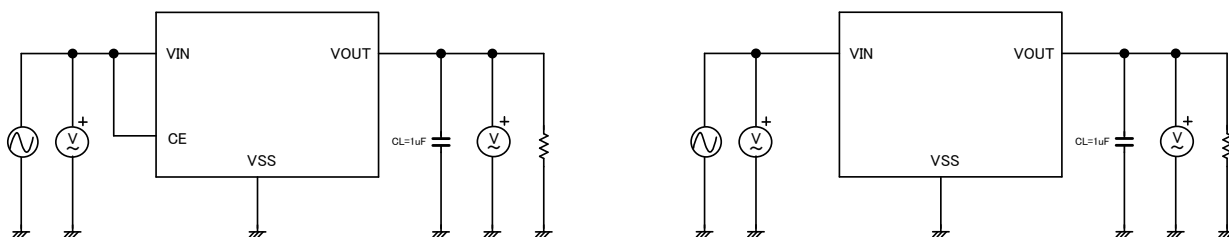

TYPICAL PERFORMANCE CHARACTERISTICS

(1) Output Voltage vs. Output Current

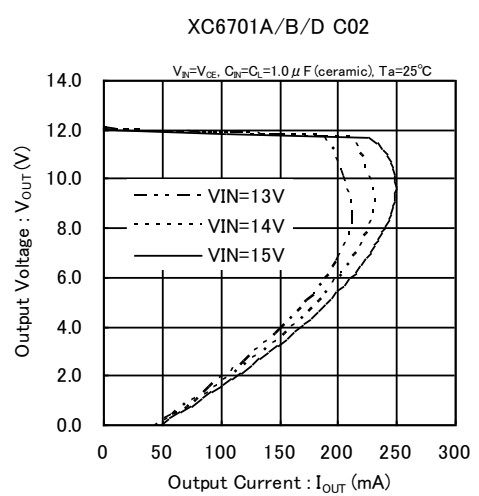
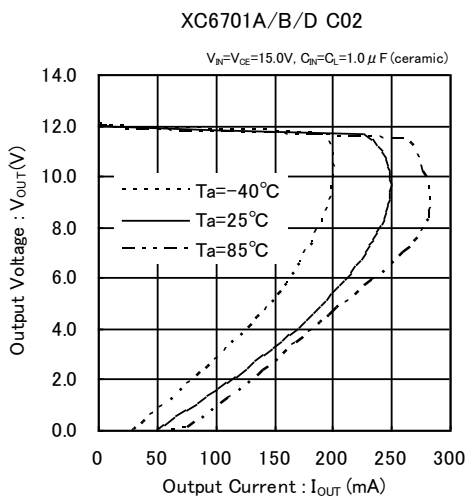
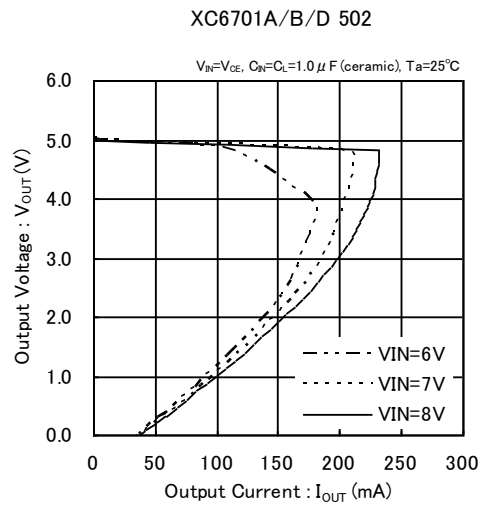
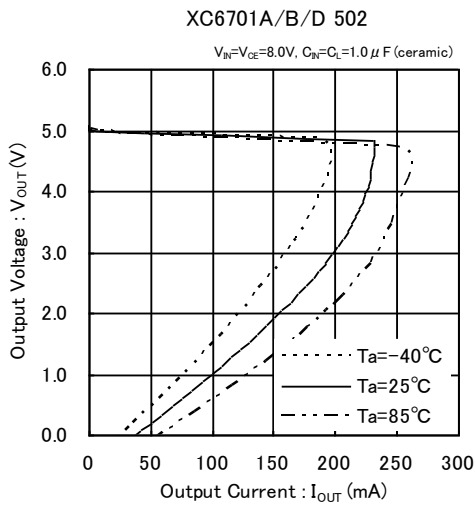
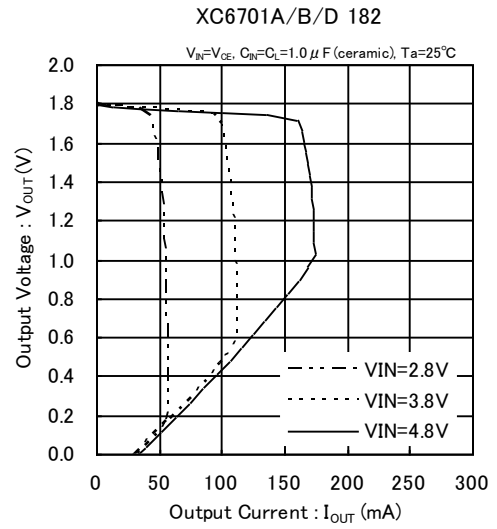
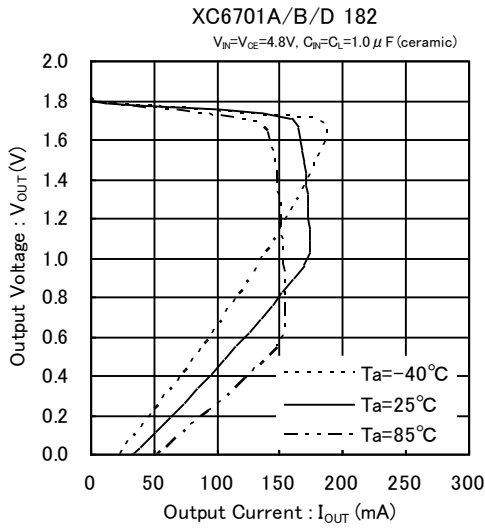

TYPICAL PERFORMANCE CHARACTERISTICS

(1) Output Voltage vs. Output Current (Continued)

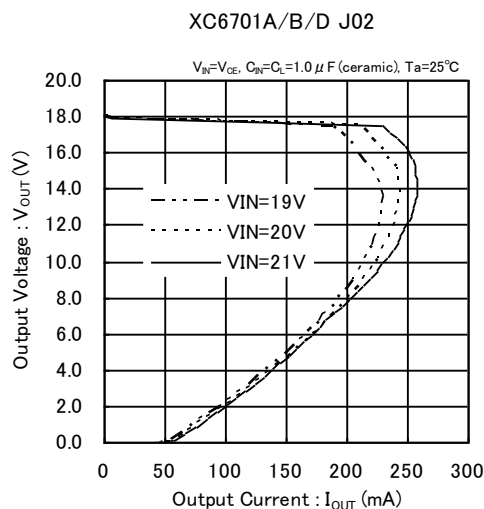
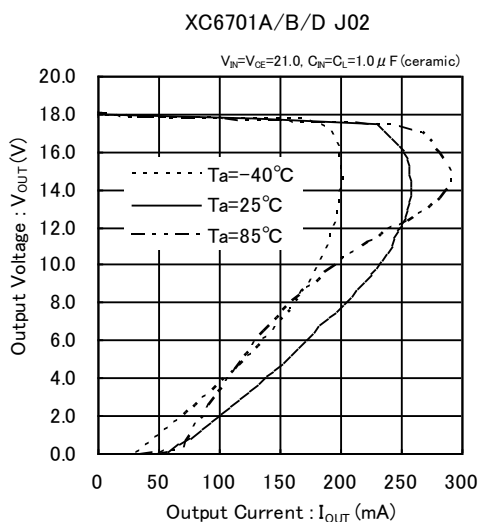

(2) Output Voltage vs. Input Voltage

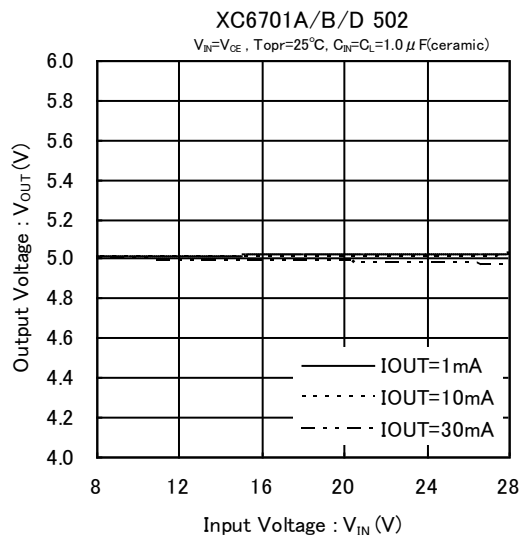
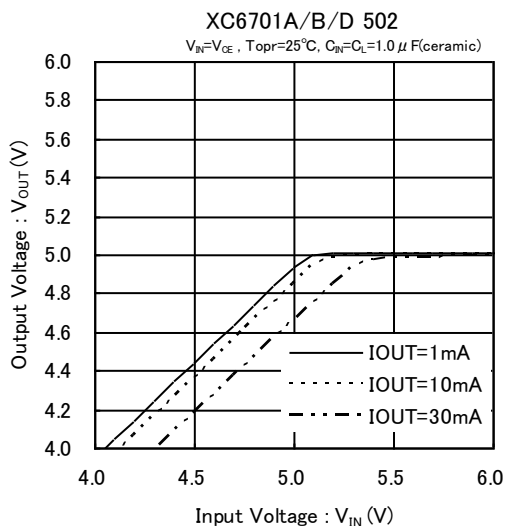
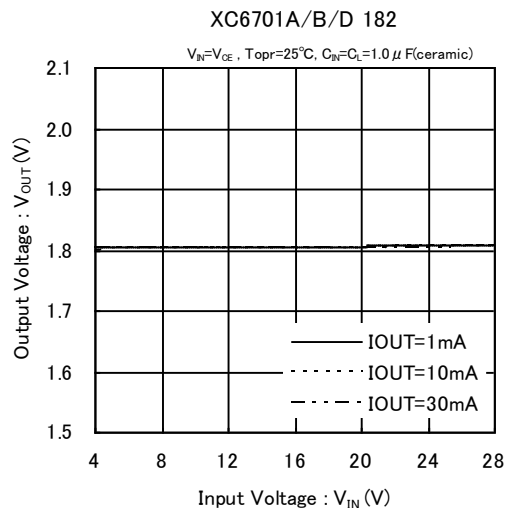
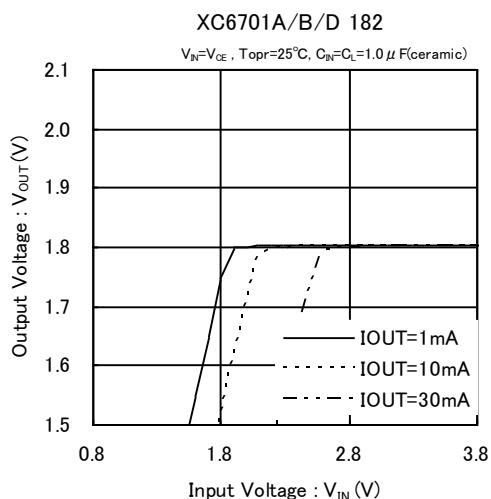

TYPICAL PERFORMANCE CHARACTERISTICS

(2) Output Voltage vs. Input Voltage

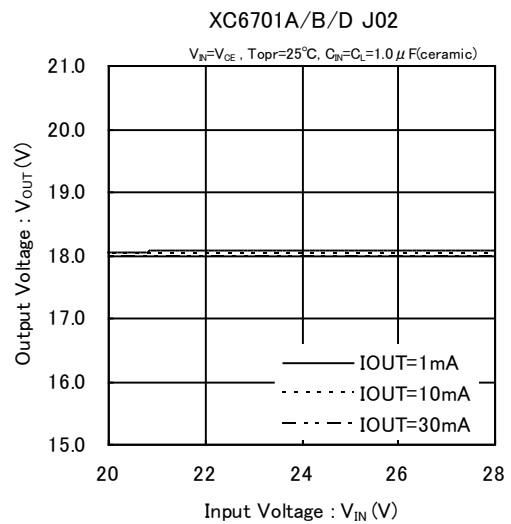
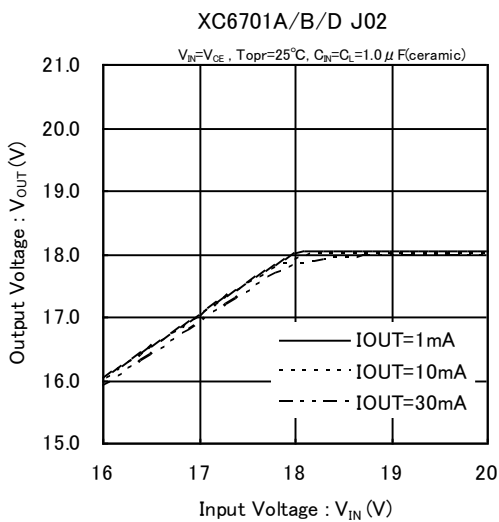
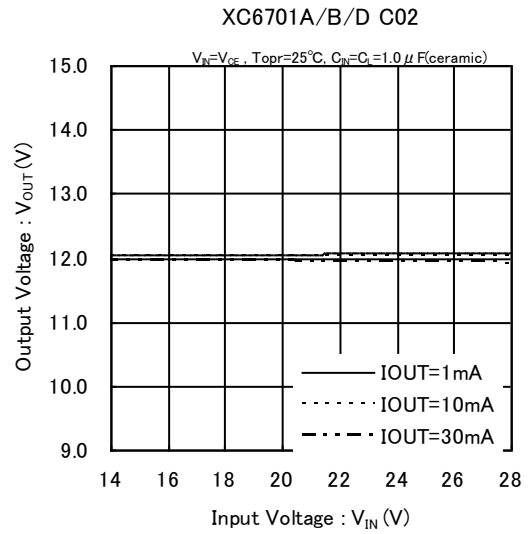
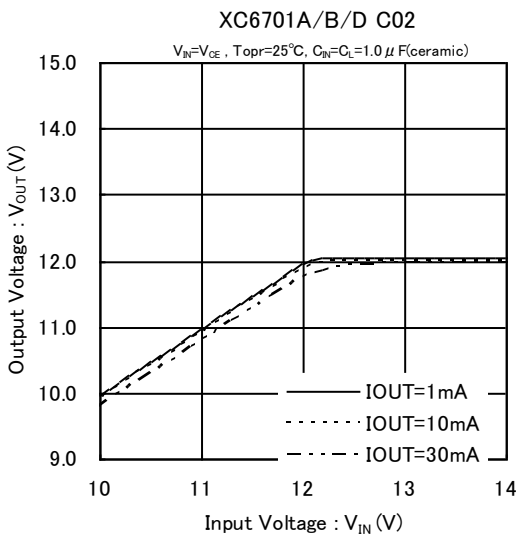

(3) Dropout Voltage vs. Output Current

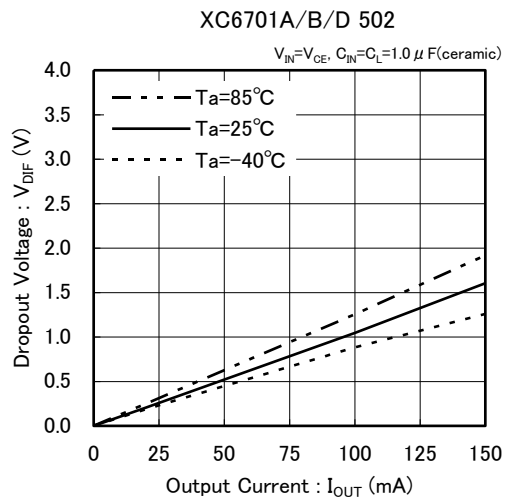
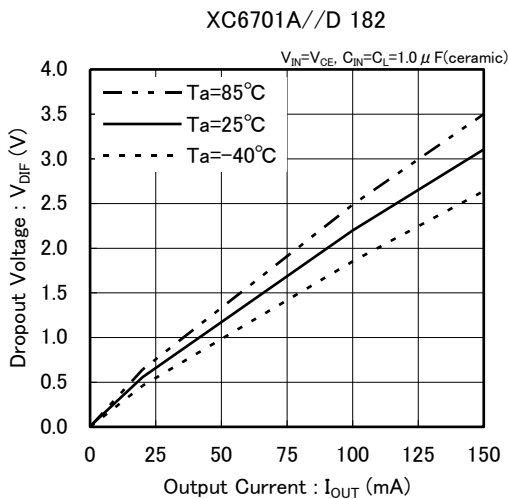

TYPICAL PERFORMANCE CHARACTERISTICS

(3) Dropout Voltage vs. Output Current (Continued)

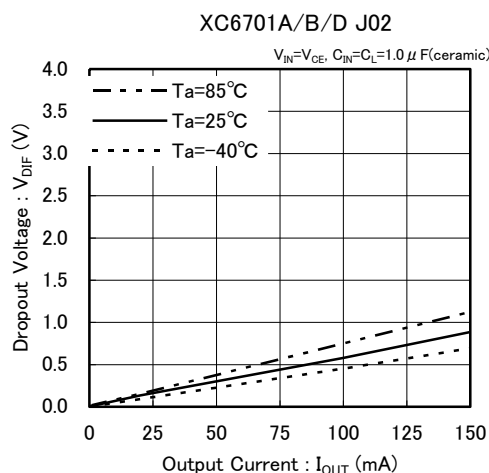
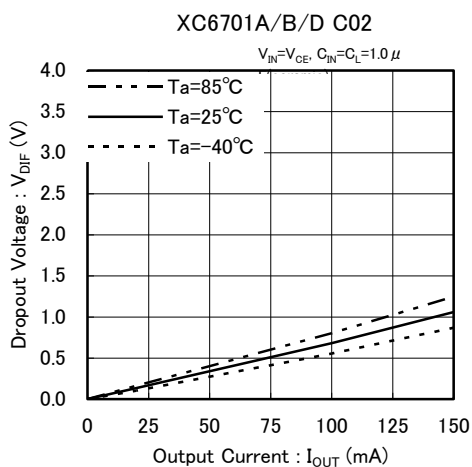

(4) Supply Current vs. Input Voltage

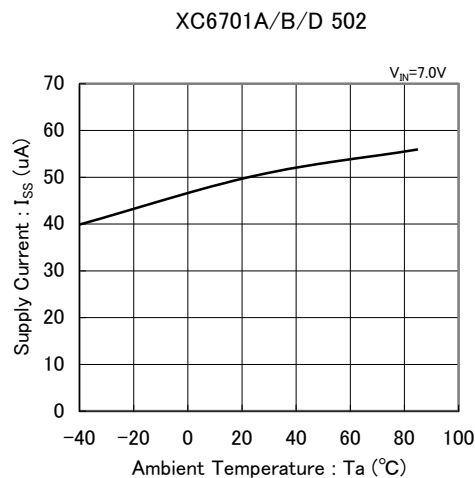
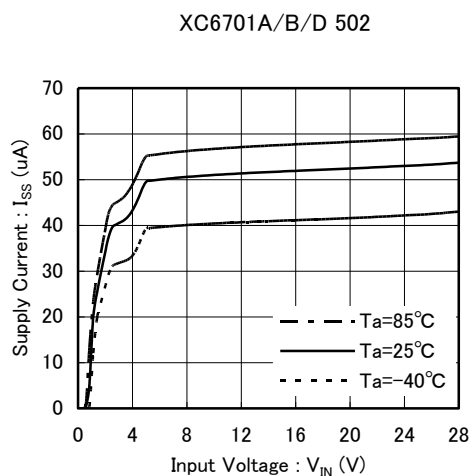
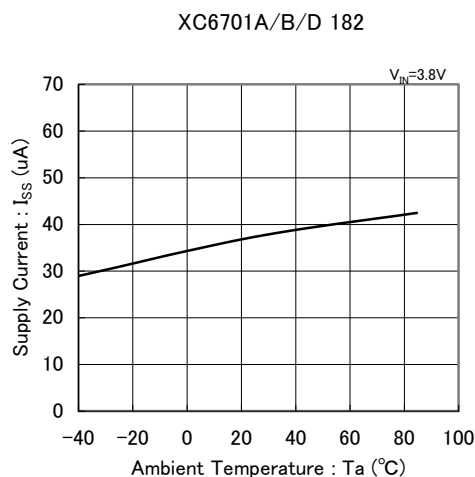
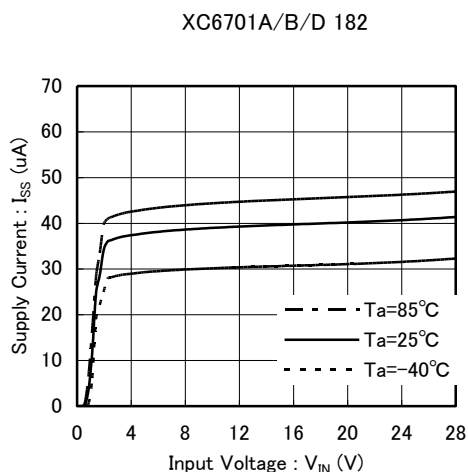

TYPICAL PERFORMANCE CHARACTERISTICS

(4) Supply Current vs. Input Voltage (Continued)

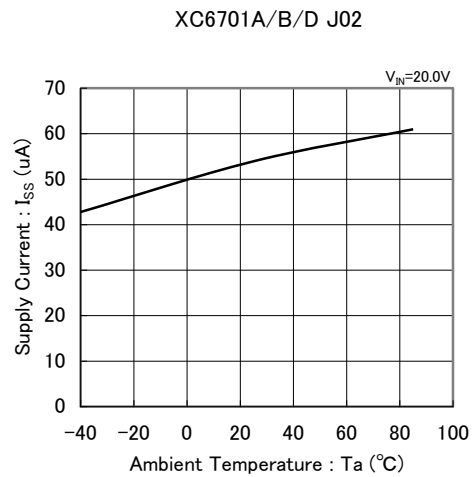
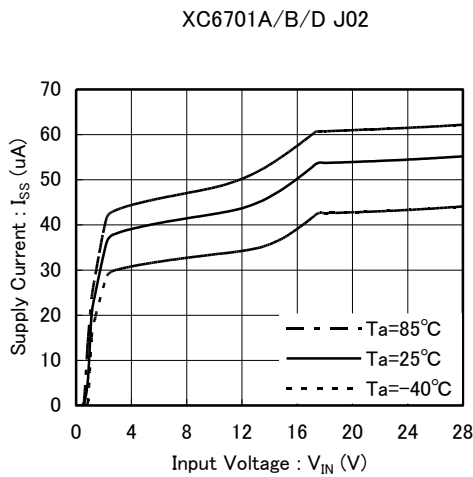
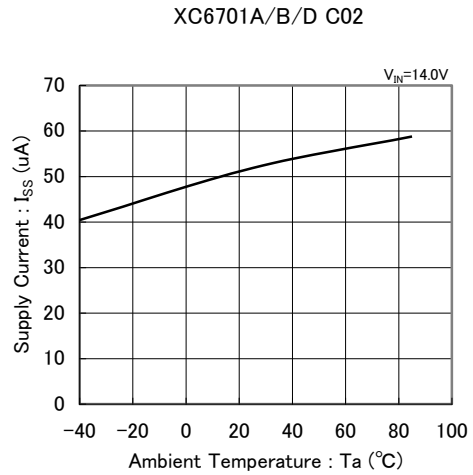
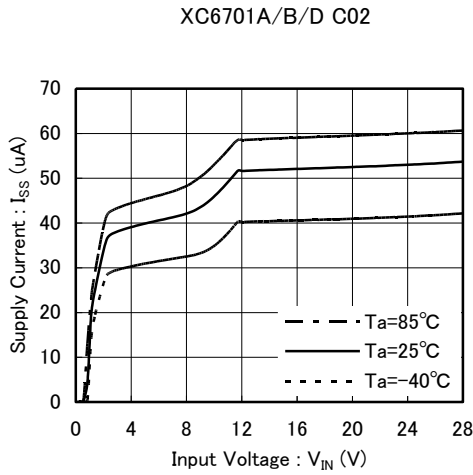

(5) Output Voltage vs. Ambient Temperature

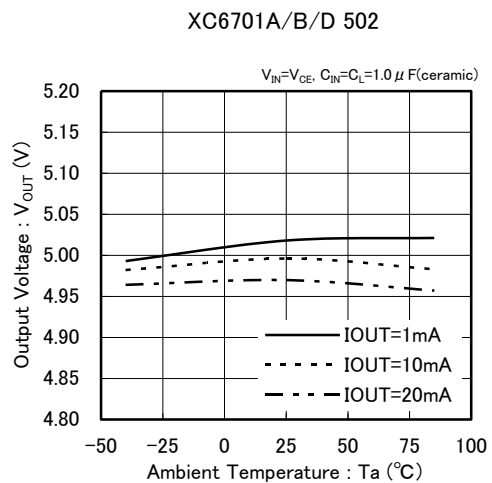
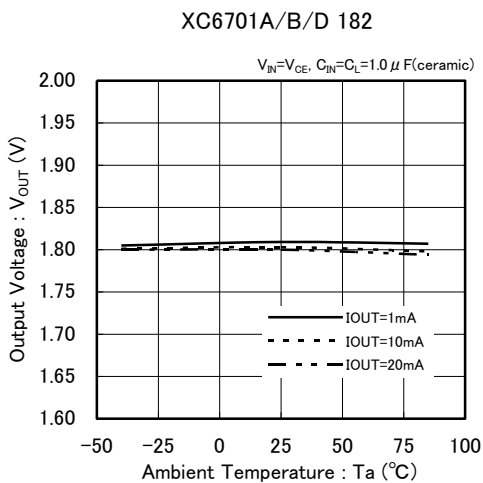

TYPICAL PERFORMANCE CHARACTERISTICS

(5) Output Voltage vs. Ambient Temperature (Continued)

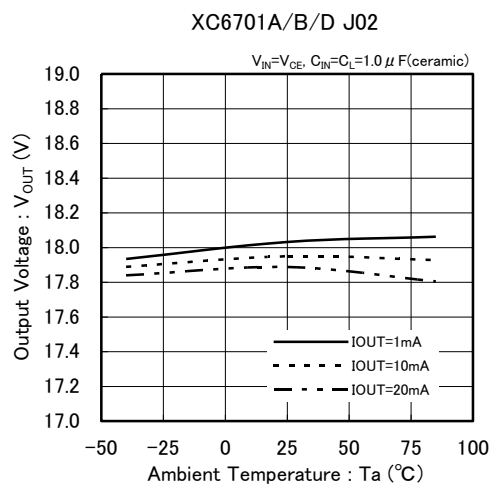
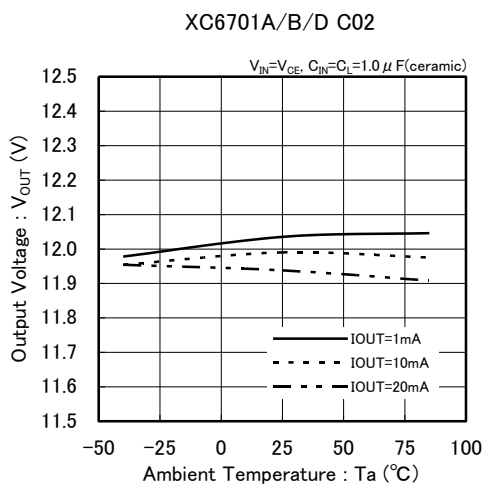

(6) Input Transient Response

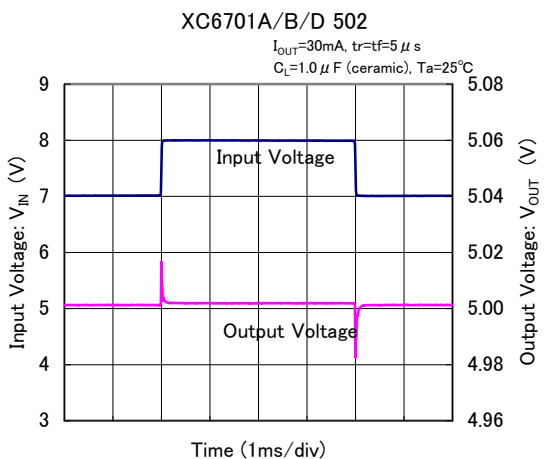
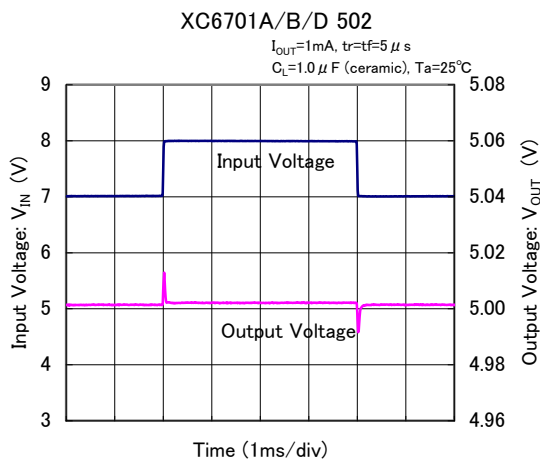
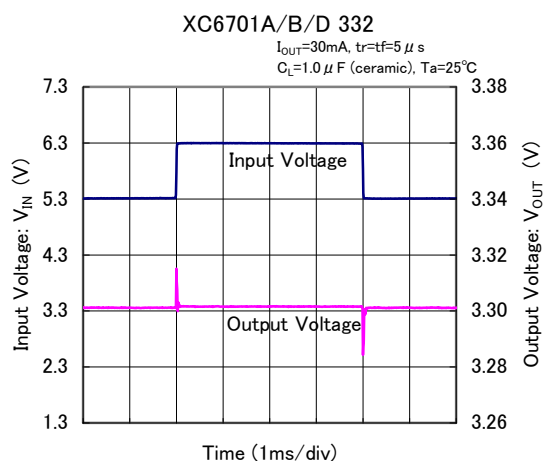
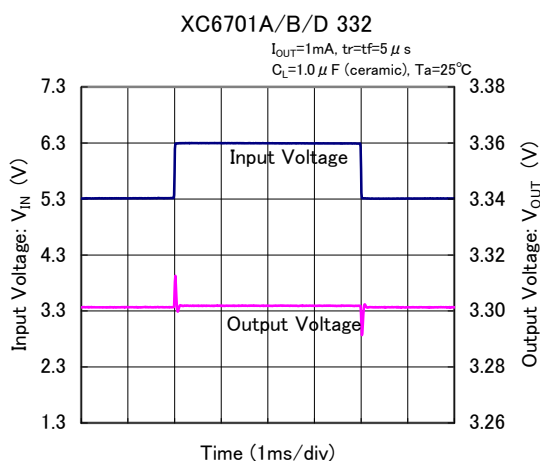

TYPICAL PERFORMANCE CHARACTERISTICS

(6) Input Transient Response (Continued)

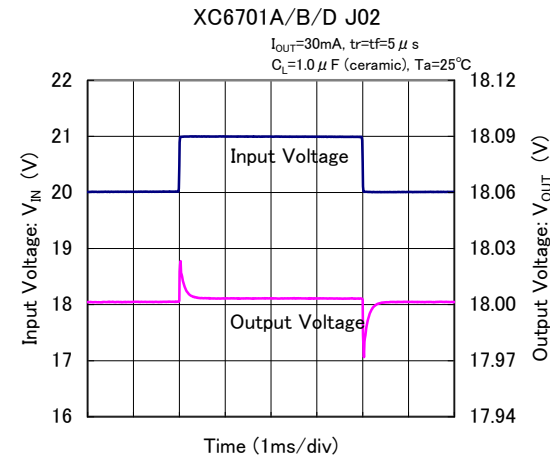
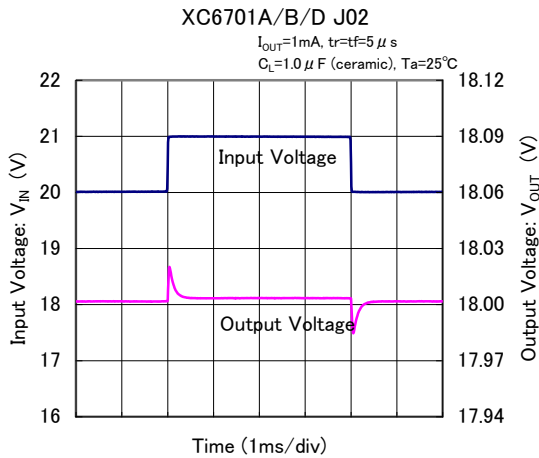
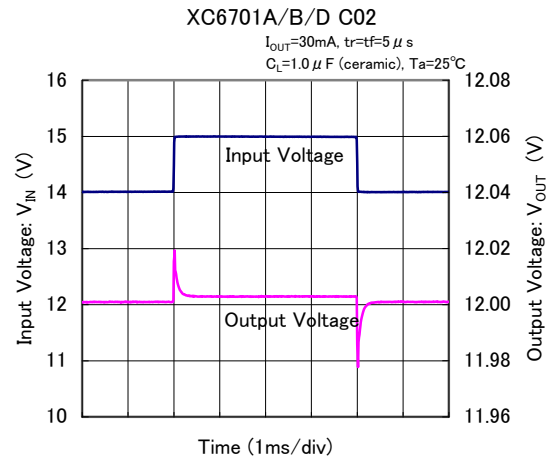
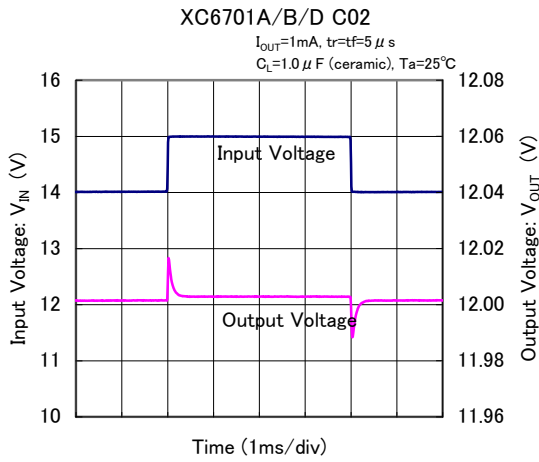

(7) Load Transient Response

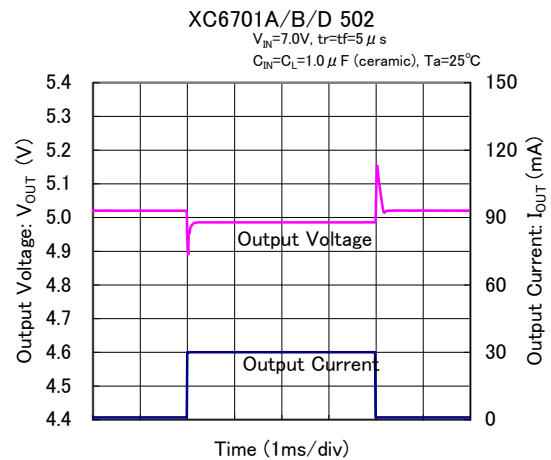
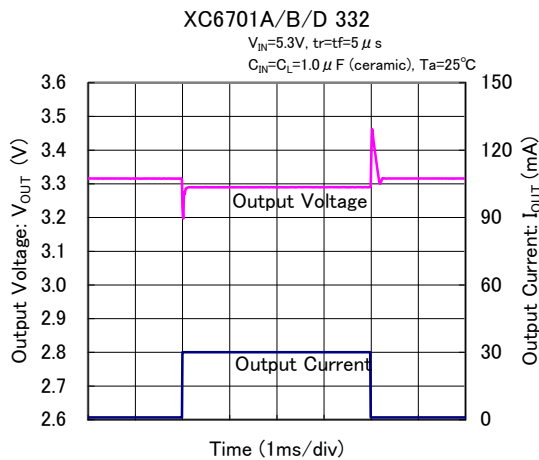

TYPICAL PERFORMANCE CHARACTERISTICS

(7) Load Transient Response (Continued)

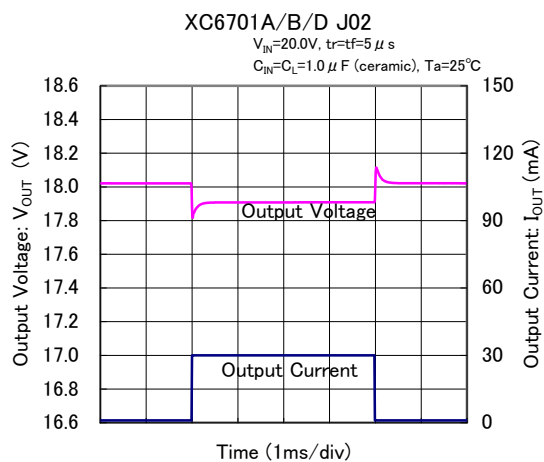
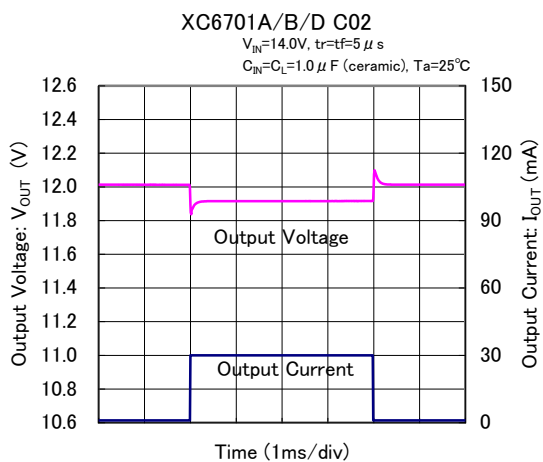

(8) Rising Response Time

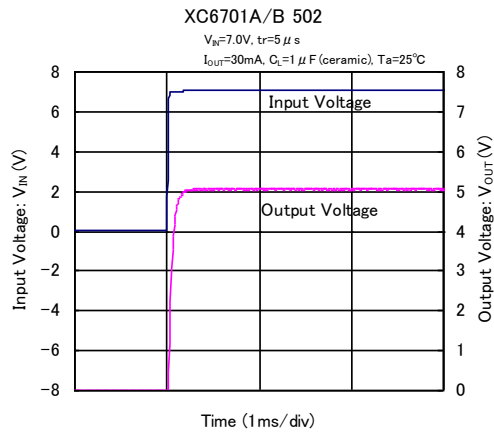
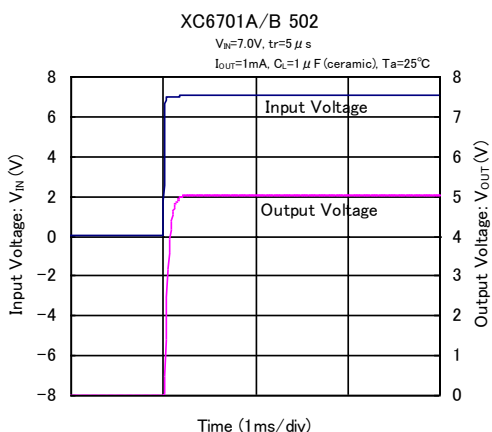
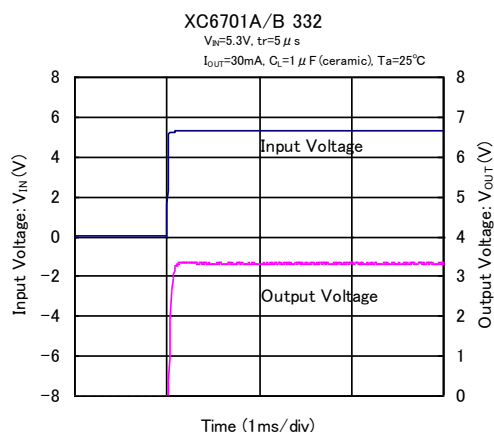
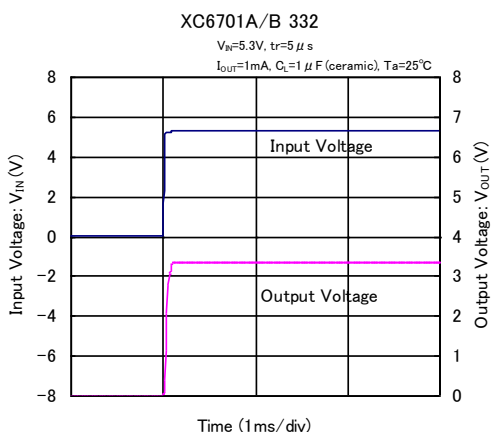

TYPICAL PERFORMANCE CHARACTERISTICS

(8) Rising Response Time (Continued)

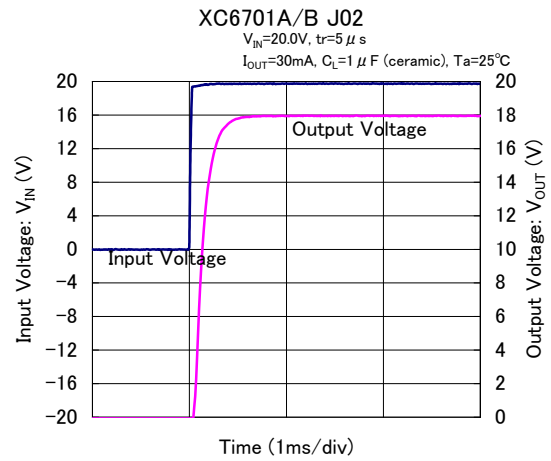
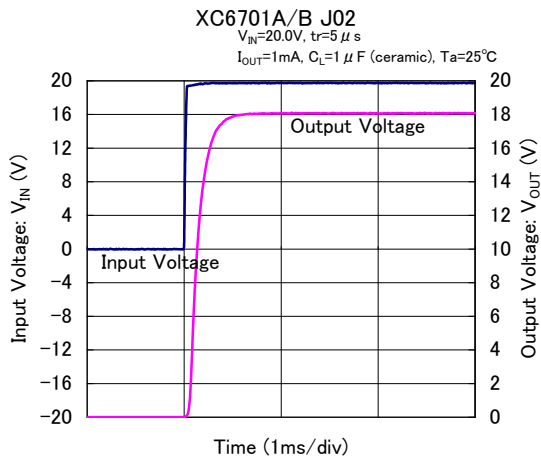
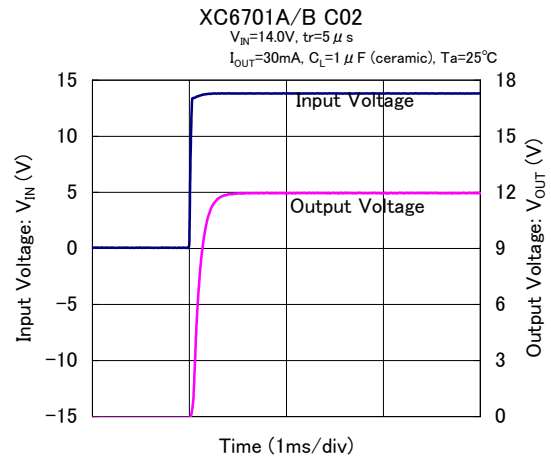
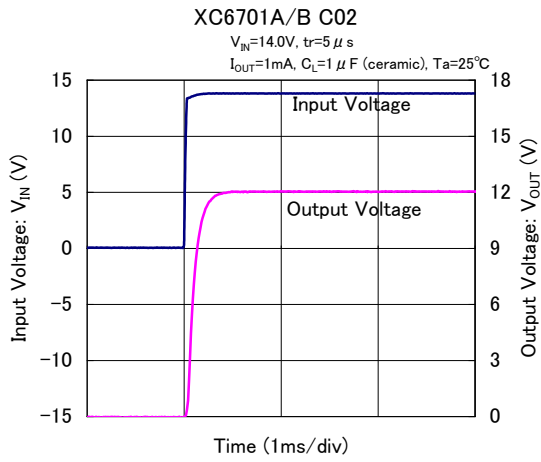

(9) CE Rising Response Time

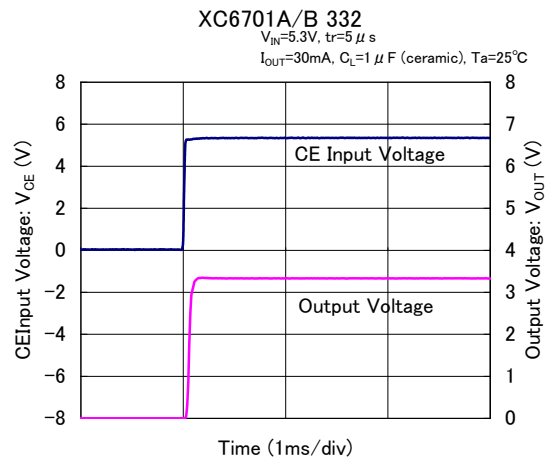
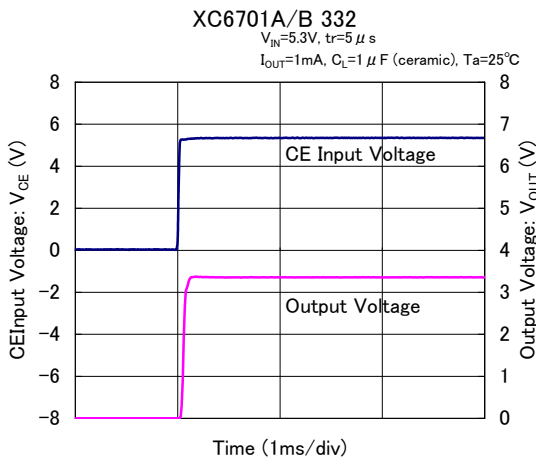

TYPICAL PERFORMANCE CHARACTERISTICS

(9) CE Rising Response Time (Continued)

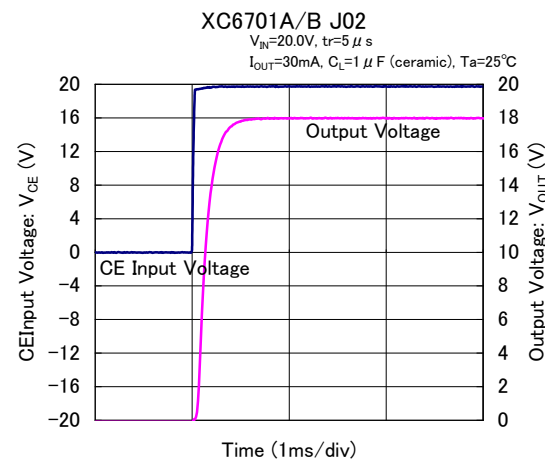
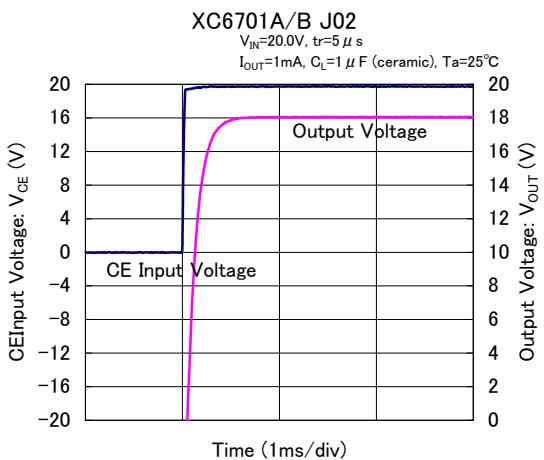
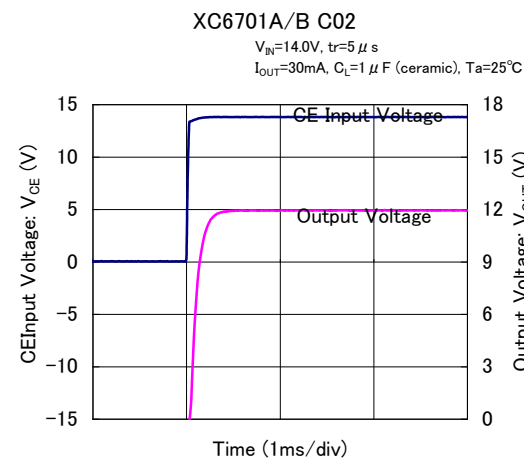
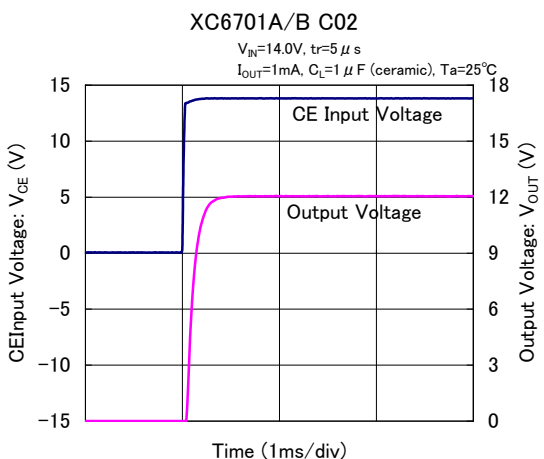
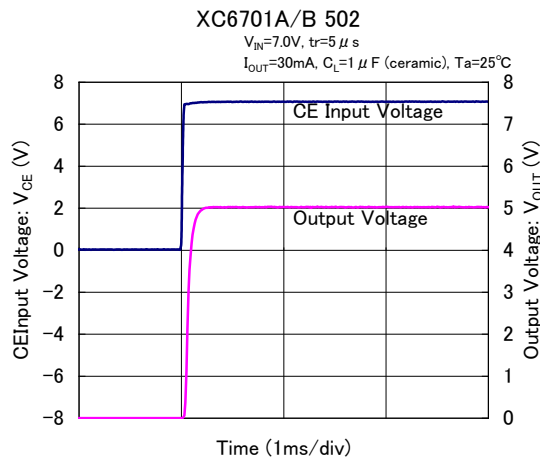
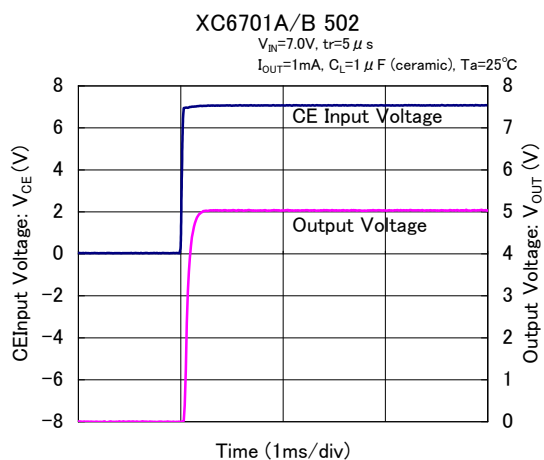

TYPICAL PERFORMANCE CHARACTERISTICS

(10) Ripple Rejection Rate

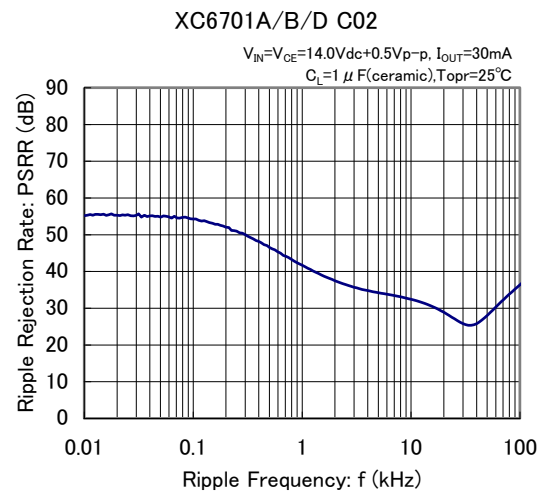
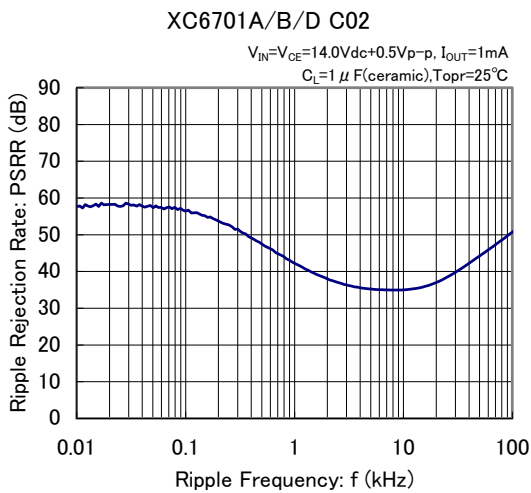
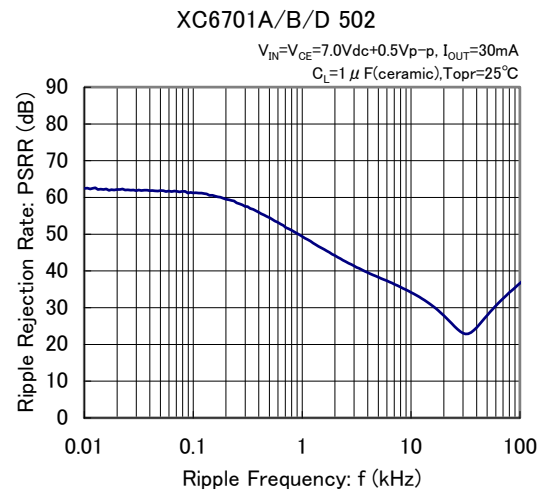
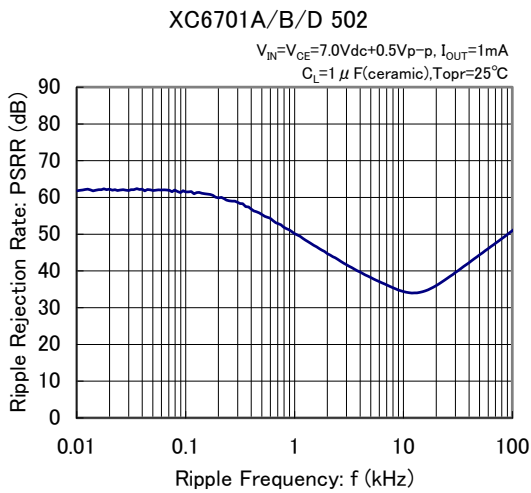
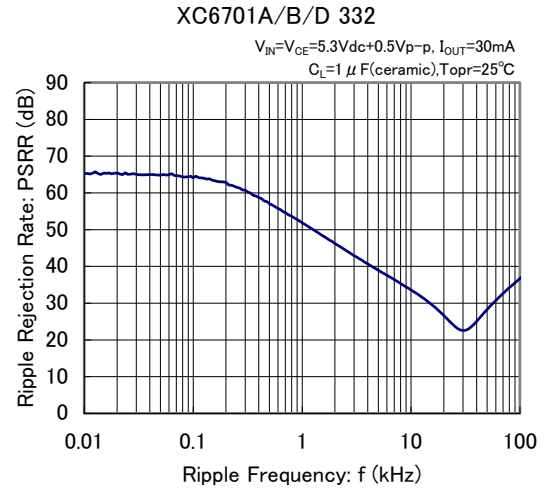
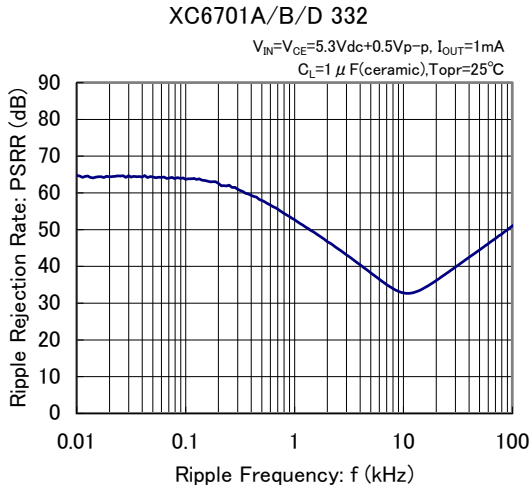

■ TYPICAL PERFORMANCE CHARACTERISTICS

(10) Ripple Rejection Rate (Continued)

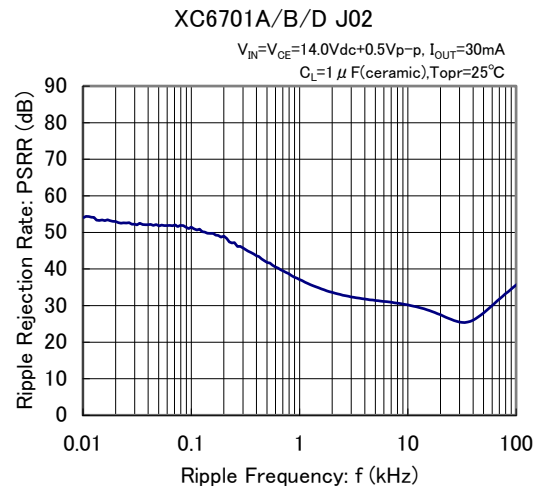
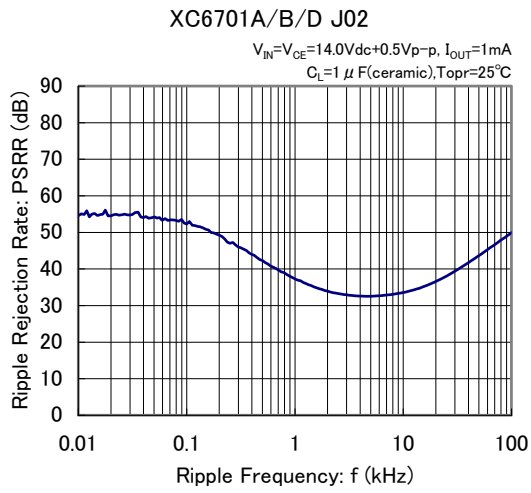

■ PACKAGING INFORMATION

For the latest package information go to, www.torexsemi.com/technical-support/packages

PACKAGE	OUTLINE / LAND PATTERN	THERMAL CHARACTERISTICS
SOT-223	SOT-223 PKG	SOT-223 Power Dissipation
SOT-25	SOT-25 PKG	SOT-25 Power Dissipation
SOT-89	SOT-89 PKG	SOT-89 Power Dissipation
SOT-89-5	SOT-89-5 PKG	SOT-89-5 Power Dissipation
TO-252	TO-252 PKG	TO-252 Power Dissipation
USP-6C	USP-6C PKG	USP-6C Power Dissipation

MARKING RULE

(mark header : ①~③) *Mark header does not change with a lot.

① represents product series

MARK	PRODUCT SERIES
8	XC6701*****

② represents type of regulators and output voltage

MARK	TYPE	OUTPUT VOLTAGE (V)	PRODUCT SERIES
0	A/B	1.8~3.0	XC6701 A/B*****
1		3.1~6.0	
2		6.1~9.0	
3		9.1~12.0	
A		12.1~15.0	
B	15.1~18.0		
4	D	1.8~3.0	XC6701D*****
5		3.1~6.0	
6		6.1~9.0	
7		9.1~12.0	
C		12.1~15.0	
D	15.1~18.0		

SOT-25

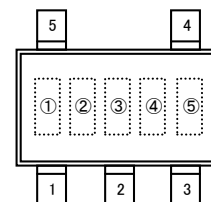

SOT-89

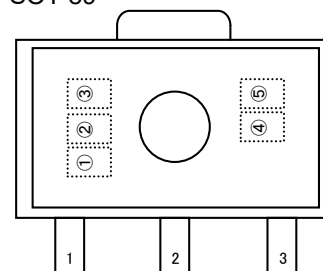

SOT-89-5

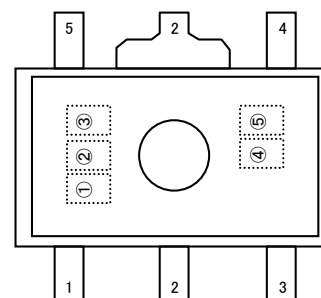

SOT-223

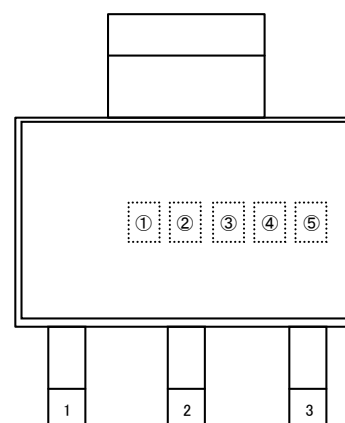

MARKING RULE (Continued)

③ represents output voltage

MARK	OUTPUT VOLTAGE(V)					
	-	3.1	6.1	9.1	12.1	15.1
0	-	3.1	6.1	9.1	12.1	15.1
1	-	3.2	6.2	9.2	12.2	15.2
2	-	3.3	6.3	9.3	12.3	15.3
3	-	3.4	6.4	9.4	12.4	15.4
4	-	3.5	6.5	9.5	12.5	15.5
5	-	3.6	6.6	9.6	12.6	15.6
6	-	3.7	6.7	9.7	12.7	15.7
7	-	3.8	6.8	9.8	12.8	15.8
8	-	3.9	6.9	9.9	12.9	15.9
9	-	4.0	7.0	10.0	13.0	16.0
A	-	4.1	7.1	10.1	13.1	16.1
B	-	4.2	7.2	10.2	13.2	16.2
C	-	4.3	7.3	10.3	13.3	16.3
D	-	4.4	7.4	10.4	13.4	16.4
E	-	4.5	7.5	10.5	13.5	16.5
F	-	4.6	7.6	10.6	13.6	16.6
H	-	4.7	7.7	10.7	13.7	16.7
K	1.8	4.8	7.8	10.8	13.8	16.8
L	1.9	4.9	7.9	10.9	13.9	16.9
M	2.0	5.0	8.0	11.0	14.0	17.0
N	2.1	5.1	8.1	11.1	14.1	17.1
P	2.2	5.2	8.2	11.2	14.2	17.2
R	2.3	5.3	8.3	11.3	14.3	17.3
S	2.4	5.4	8.4	11.4	14.4	17.4
T	2.5	5.5	8.5	11.5	14.5	17.5
U	2.6	5.6	8.6	11.6	14.6	17.6
V	2.7	5.7	8.7	11.7	14.7	17.7
X	2.8	5.8	8.8	11.8	14.8	17.8
Y	2.9	5.9	8.9	11.9	14.9	17.9
Z	3.0	6.0	9.0	12.0	15.0	18.0

TO-252

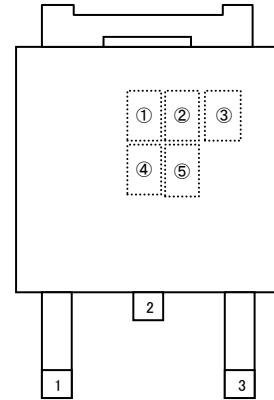

USP-6C

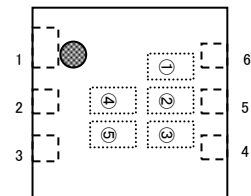

④⑤ represents production lot number

01, ..., 09, 10, 11, ..., 99, 0A, ..., 0Z, 1A, ..., 9Z, A0, ..., Z9, AA, ..., ZZ repeated.

(G, I, J, O, Q, W excluded)

*No character inversion used.

1. The product and product specifications contained herein are subject to change without notice to improve performance characteristics. Consult us, or our representatives before use, to confirm that the information in this datasheet is up to date.
2. The information in this datasheet is intended to illustrate the operation and characteristics of our products. We neither make warranties or representations with respect to the accuracy or completeness of the information contained in this datasheet nor grant any license to any intellectual property rights of ours or any third party concerning with the information in this datasheet.
3. Applicable export control laws and regulations should be complied and the procedures required by such laws and regulations should also be followed, when the product or any information contained in this datasheet is exported.
4. The product is neither intended nor warranted for use in equipment of systems which require extremely high levels of quality and/or reliability and/or a malfunction or failure which may cause loss of human life, bodily injury, serious property damage including but not limited to devices or equipment used in 1) nuclear facilities, 2) aerospace industry, 3) medical facilities, 4) automobile industry and other transportation industry and 5) safety devices and safety equipment to control combustions and explosions. Do not use the product for the above use unless agreed by us in writing in advance.
5. Although we make continuous efforts to improve the quality and reliability of our products; nevertheless Semiconductors are likely to fail with a certain probability. So in order to prevent personal injury and/or property damage resulting from such failure, customers are required to incorporate adequate safety measures in their designs, such as system fail safes, redundancy and fire prevention features.
6. Our products are not designed to be Radiation-resistant.
7. Please use the product listed in this datasheet within the specified ranges.
8. We assume no responsibility for damage or loss due to abnormal use.
9. All rights reserved. No part of this datasheet may be copied or reproduced unless agreed by Torex Semiconductor Ltd in writing in advance.

TOREX SEMICONDUCTOR LTD.