

N-channel 400 V, 0.59 Ω typ., 6 A MDmesh™ M2 Power MOSFET in a DPAK package

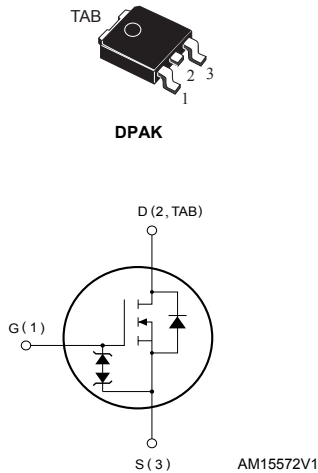

Features

Order code	$V_{DS} @ T_{Jmax}$	$R_{DS(on)max.}$	I_D
STD9N40M2	450 V	0.8 Ω	6 A

- Extremely low gate charge
- Excellent output capacitance (C_{OSS}) profile
- 100% avalanche tested
- Zener-protected

Applications

- Switching applications

Description

This device is an N-channel Power MOSFET developed using MDmesh™ M2 technology. Thanks to its strip layout and an improved vertical structure, the device exhibits low on-resistance and optimized switching characteristics, rendering it suitable for the most demanding high efficiency converters.

Product status	
STD9N40M2	
Product summary	
Order code	STD9N40M2
Marking	9N40M2
Package	DPAK
Packing	Tape and reel

1 Electrical ratings

Table 1. Absolute maximum ratings

Symbol	Parameter	Value	Unit
V_{DS}	Drain-source voltage	400	V
V_{GS}	Gate-source voltage	± 25	V
I_D	Drain current (continuous) at $T_C = 25\text{ }^\circ\text{C}$	6	A
I_D	Drain current (continuous) at $T_C = 100\text{ }^\circ\text{C}$	3.8	A
$I_{DM}^{(1)}$	Drain current (pulsed)	24	A
P_{TOT}	Total dissipation at $T_C = 25\text{ }^\circ\text{C}$	60	W
$dv/dt^{(2)}$	Peak diode recovery voltage slope	15	V/ns
$dv/dt^{(3)}$	MOSFET dv/dt ruggedness	50	V/ns
T_j	Operating junction temperature range	-55 to 150	$^\circ\text{C}$
T_{stg}	Storage temperature range		

1. Pulse width limited by safe operating area.
2. $I_{SD} \leq 6\text{ A}$, $di/dt \leq 400\text{ A}/\mu\text{s}$; $V_{DS\ peak} < V_{(BR)DSS}$, $V_{DD} = 320\text{ V}$.
3. $V_{DS} \leq 320\text{ V}$.

Table 2. Thermal data

Symbol	Parameter	Value	Unit
$R_{thj-case}$	Thermal resistance junction-case	2.08	$^\circ\text{C}/\text{W}$
$R_{thj-pcb}^{(1)}$	Thermal resistance junction-pcb	50	$^\circ\text{C}/\text{W}$

1. When mounted on 1 inch² FR-4, 2 Oz copper board.

Table 3. Avalanche characteristics

Symbol	Parameter	Value	Unit
I_{AR}	Avalanche current, repetitive or not-repetitive (pulse width limited by T_{jmax})	2.5	A
E_{AS}	Single pulse avalanche energy (starting $T_j = 25\text{ }^\circ\text{C}$, $I_D = I_{AR}$, $V_{DD} = 50\text{ V}$)	148	mJ

2 Electrical characteristics

($T_{CASE} = 25\text{ °C}$ unless otherwise specified)

Table 4. On/off states

Symbol	Parameter	Test conditions	Min.	Typ.	Max.	Unit
$V_{(BR)DSS}$	Drain-source breakdown voltage	$I_D = 1\text{ mA}$, $V_{GS} = 0\text{ V}$	400			V
I_{DSS}	Zero gate voltage drain current	$V_{DS} = 400\text{ V}$, $V_{GS} = 0\text{ V}$			1	μA
		$V_{DS} = 400\text{ V}$, $V_{GS} = 0\text{ V}$, $T_C = 125\text{ °C}$ ⁽¹⁾			100	μA
I_{GSS}	Gate body leakage current	$V_{DS} = 0\text{ V}$, $V_{GS} = \pm 25\text{ V}$			± 10	μA
$V_{GS(th)}$	Gate threshold voltage	$V_{DS} = V_{GS}$, $I_D = 250\text{ }\mu\text{A}$	2	3	4	V
$R_{DS(on)}$	Static drain-source on resistance	$V_{GS} = 10\text{ V}$, $I_D = 3\text{ A}$		0.59	0.8	Ω

1. Defined by design, not subject to production test.

Table 5. Dynamic

Symbol	Parameter	Test conditions	Min.	Typ.	Max.	Unit
C_{iss}	Input capacitance	$V_{DS} = 100\text{ V}$, $f = 1\text{ MHz}$, $V_{GS} = 0\text{ V}$	-	270	-	μF
C_{oss}	Output capacitance			22		
C_{rss}	Reverse transfer capacitance			0.7		
$C_{oss\text{ eq.}}^{(1)}$	Equivalent output capacitance	$V_{GS} = 0\text{ V}$, $V_{DS} = 0\text{ to }320\text{ V}$	-	94	-	μF
R_g	Gate input resistance	$f = 1\text{ MHz}$ open drain	-	7.1	-	Ω
Q_g	Total gate charge	$V_{DD} = 320\text{ V}$, $I_D = 6\text{ A}$, $V_{GS} = 0\text{ to }10\text{ V}$ (see Figure 14. Test circuit for gate charge behavior)	-	8.8	-	nC
Q_{gs}	Gate-source charge			1.7		
Q_{gd}	Gate-drain charge			4.8		

1. $C_{oss\text{ eq.}}$ is defined as a constant equivalent capacitance giving the same charging time as C_{oss} when V_{DS} increases from 0 to 80% V_{DSS} .

Table 6. Switching times

Symbol	Parameter	Test conditions	Min.	Typ.	Max.	Unit
$t_{d(on)}$	Turn-on delay time	$V_{DD} = 200\text{ V}$, $I_D = 3\text{ A}$, $R_G = 4.7\text{ }\Omega$, $V_{GS} = 10\text{ V}$ (see Figure 13. Test circuit for resistive load switching times and Figure 18. Switching time waveform)	-	10.5	-	ns
t_r	Rise time			9		
$t_{d(off)}$	Turn-off delay time			7.5		
t_f	Fall time			21		

Table 7. Source drain diode

Symbol	Parameter	Test conditions	Min.	Typ.	Max.	Unit
I_{SD}	Source-drain current				6	A
$I_{SDM}^{(1)}$	Source-drain current (pulsed)		-		24	
$V_{SD}^{(2)}$	Forward on voltage	$I_{SD} = 6\text{ A}$, $V_{GS} = 0\text{ V}$	-		1.6	V
t_{rr}	Reverse recovery time	$I_{SD} = 6\text{ A}$, $di/dt = 100\text{ A}/\mu\text{s}$		208		ns
Q_{rr}	Reverse recovery charge	$V_{DD} = 60\text{ V}$ (see Figure 15. Test circuit for inductive load switching and diode recovery times)	-	1.2		μC
I_{RRM}	Reverse recovery current			11.5		A
t_{rr}	Reverse recovery time	$I_{SD} = 6\text{ A}$, $di/dt = 100\text{ A}/\mu\text{s}$		264		ns
Q_{rr}	Reverse recovery charge	$V_{DD} = 60\text{ V}$, $T_j = 150\text{ }^\circ\text{C}$ (see Figure 15. Test circuit for inductive load switching and diode recovery times)	-	1.6		μC
I_{RRM}	Reverse recovery current			12.5		A

1. Pulse width limited by safe operating area.
2. Pulsed: pulse duration = 300 μs , duty cycle 1.5%.

2.1 Electrical characteristics curves

Figure 1. Safe operating area

Figure 2. Thermal impedance

Figure 3. Output characteristics

Figure 4. Transfer characteristics

Figure 5. Gate charge vs gate-source voltage

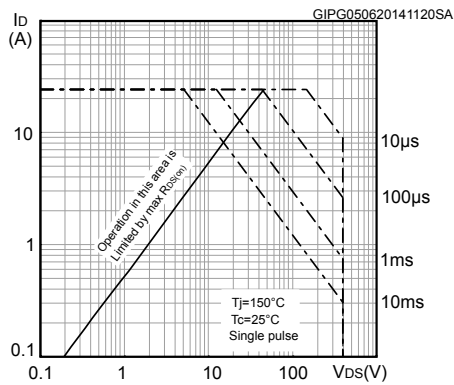
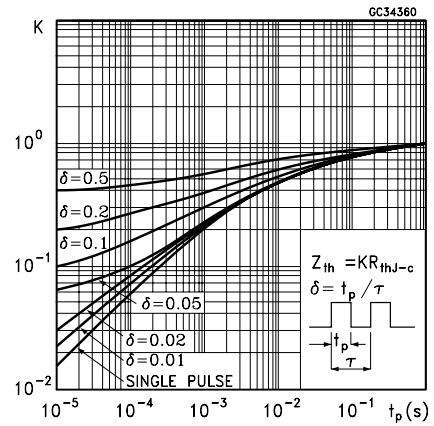
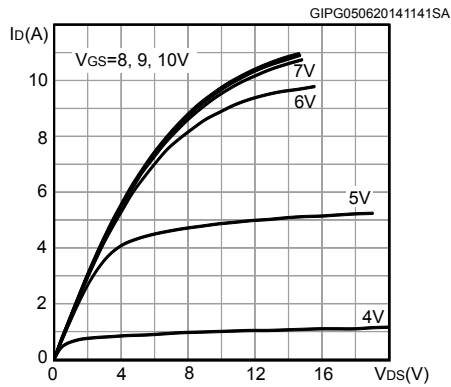
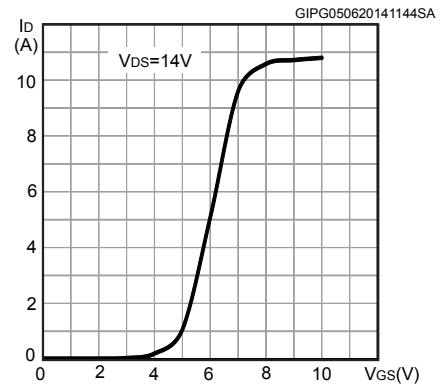
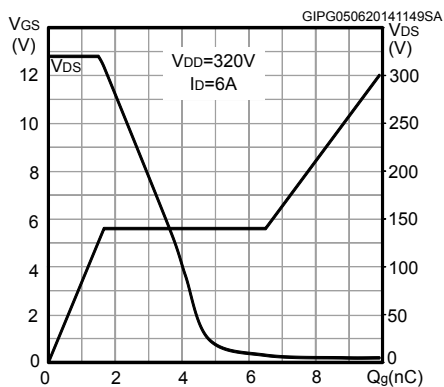
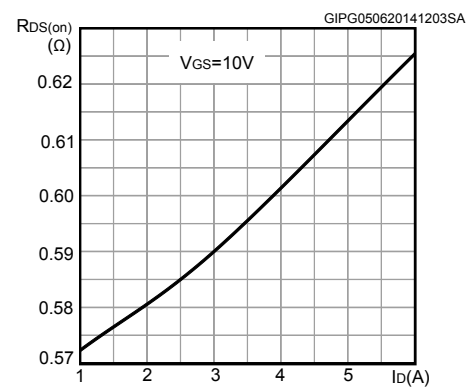
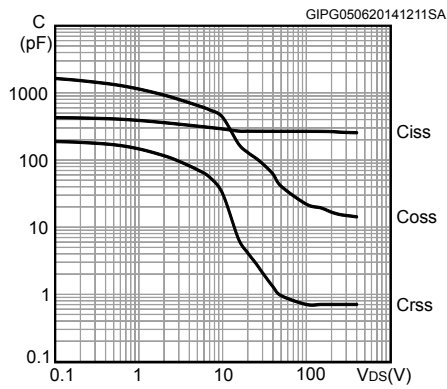
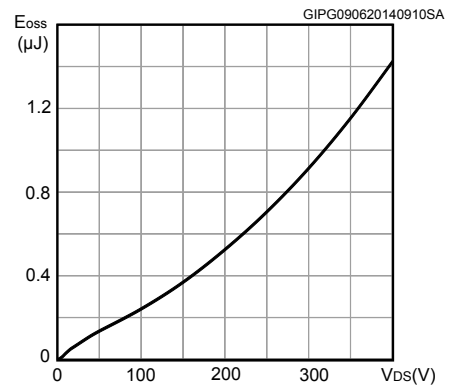
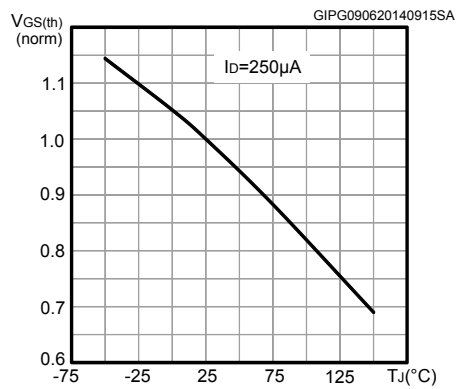
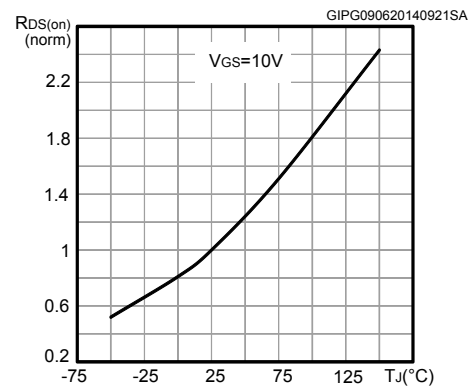
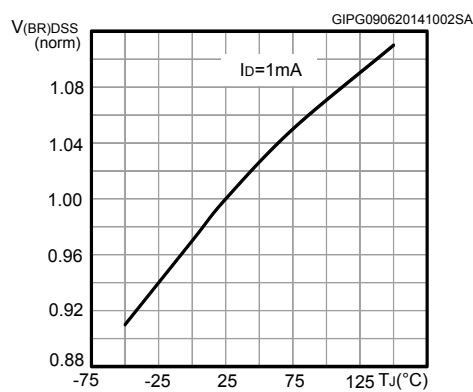
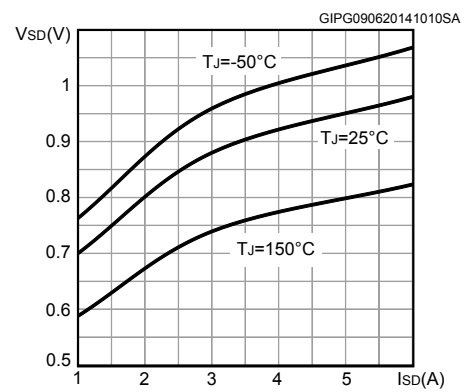
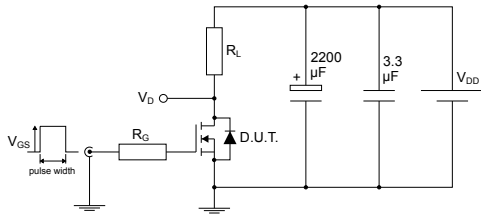
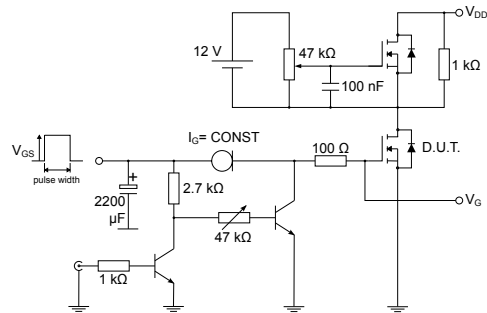
Figure 6. Static drain-source on-resistance

Figure 7. Capacitance variations

Figure 8. Output capacitance stored energy

Figure 9. Normalized gate threshold voltage vs temperature

Figure 10. Normalized on-resistance vs temperature

Figure 11. Normalized $V_{(BR)DSS}$ vs temperature

Figure 12. Source-drain diode forward characteristics

3 Test circuits

Figure 13. Test circuit for resistive load switching times

AM01468v1

Figure 14. Test circuit for gate charge behavior

AM01469v1

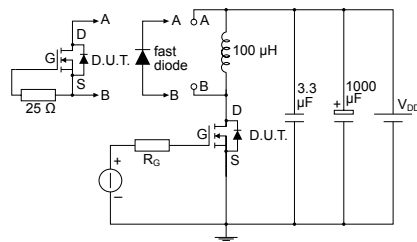
Figure 15. Test circuit for inductive load switching and diode recovery times

AM01470v1

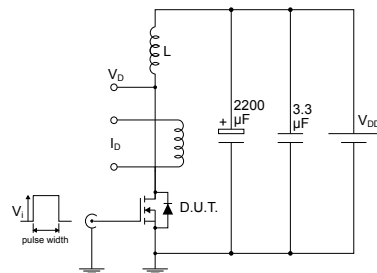
Figure 16. Unclamped inductive load test circuit

AM01471v1

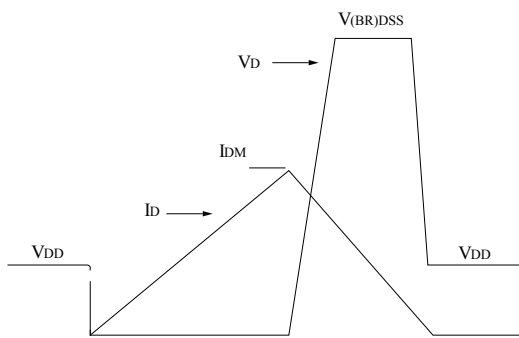
Figure 17. Unclamped inductive waveform

AM01472v1

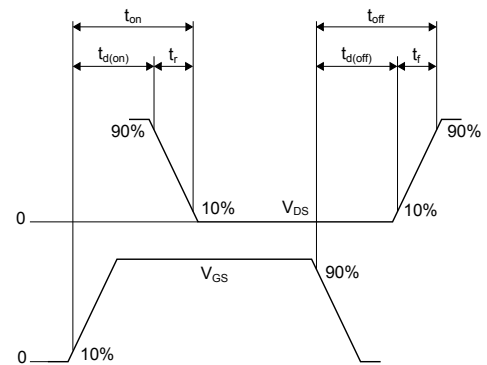
Figure 18. Switching time waveform

AM01473v1

4 Package information

In order to meet environmental requirements, ST offers these devices in different grades of ECOPACK® packages, depending on their level of environmental compliance. ECOPACK® specifications, grade definitions and product status are available at: www.st.com. ECOPACK® is an ST trademark.

4.1 DPAK (TO-252) type A package information

Figure 19. DPAK (TO-252) type A package outline

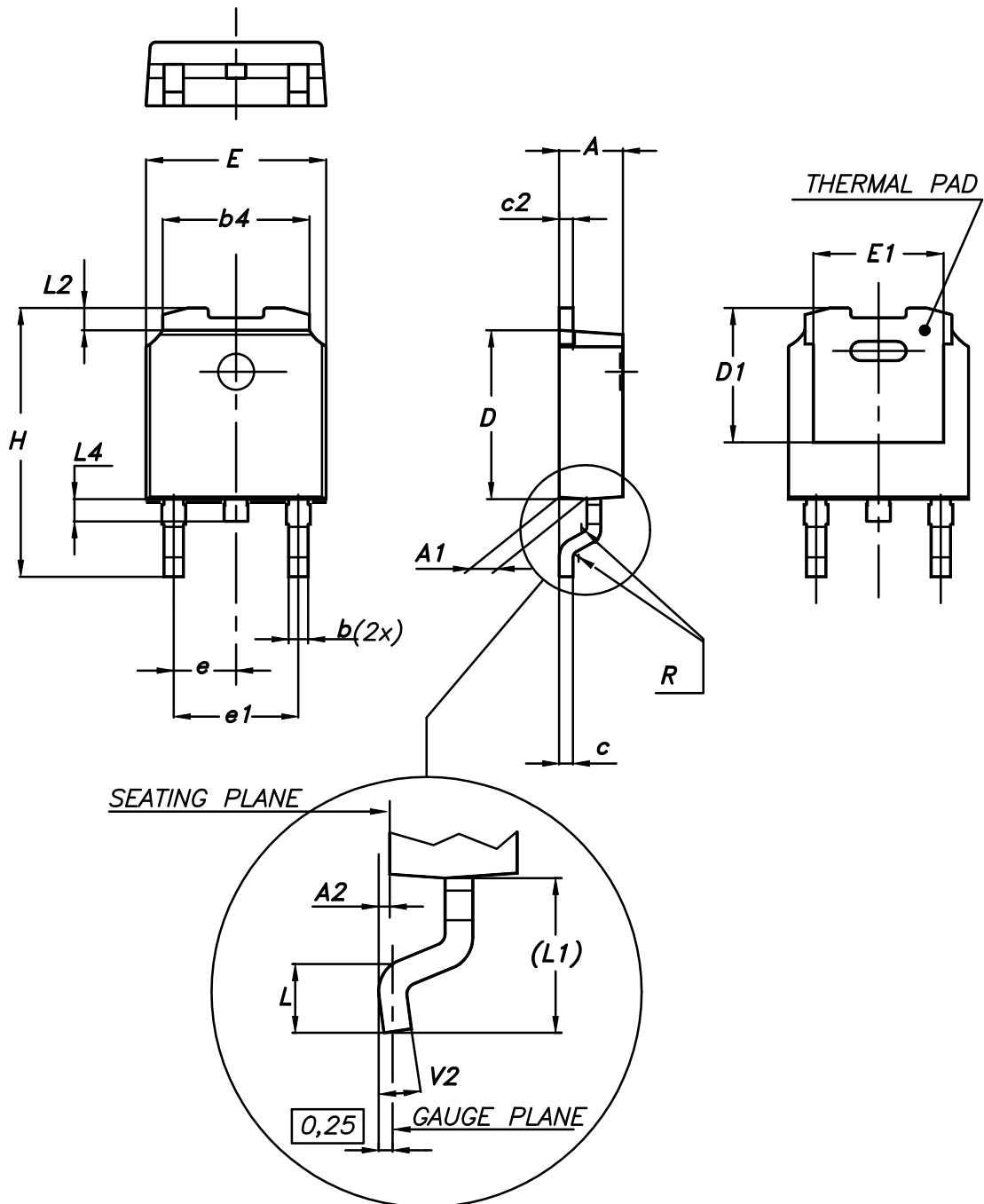

0068772_A_25

Table 8. DPAK (TO-252) type A mechanical data

Dim.	mm		
	Min.	Typ.	Max.
A	2.20		2.40
A1	0.90		1.10
A2	0.03		0.23
b	0.64		0.90
b4	5.20		5.40
c	0.45		0.60
c2	0.48		0.60
D	6.00		6.20
D1	4.95	5.10	5.25
E	6.40		6.60
E1	4.60	4.70	4.80
e	2.159	2.286	2.413
e1	4.445	4.572	4.699
H	9.35		10.10
L	1.00		1.50
(L1)	2.60	2.80	3.00
L2	0.65	0.80	0.95
L4	0.60		1.00
R		0.20	
V2	0°		8°

4.2 DPAK (TO-252) type C package information

Figure 20. DPAK (TO-252) type C package outline

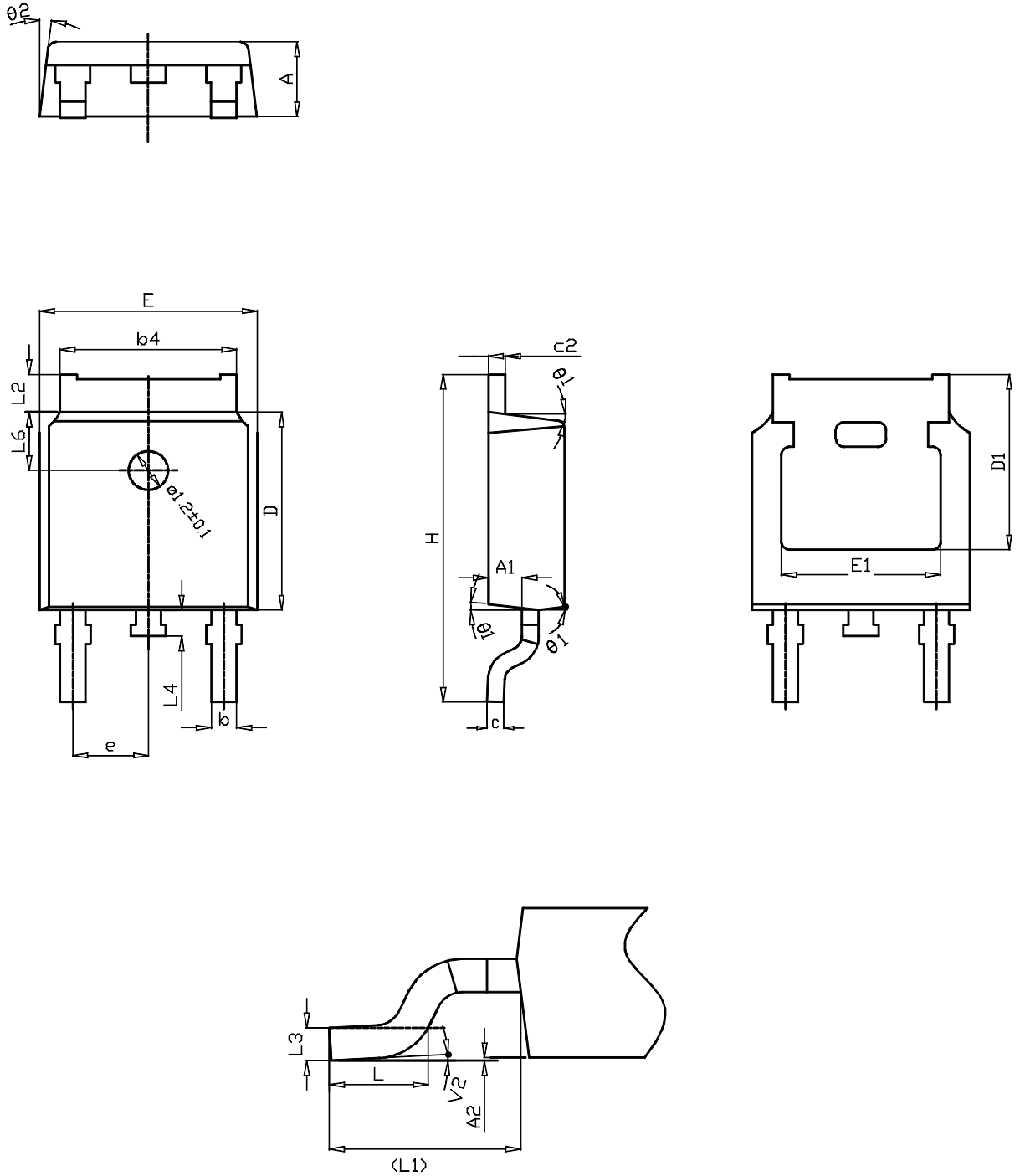

0068772_C_25

Table 9. DPAK (TO-252) type C mechanical data

Dim.	mm		
	Min.	Typ.	Max.
A	2.20	2.30	2.38
A1	0.90	1.01	1.10
A2	0.00		0.10
b	0.72		0.85
b4	5.13	5.33	5.46
c	0.47		0.60
c2	0.47		0.60
D	6.00	6.10	6.20
D1	5.25		
E	6.50	6.60	6.70
E1	4.70		
e	2.186	2.286	2.386
H	9.80	10.10	10.40
L	1.40	1.50	1.70
L1	2.90 REF		
L2	0.90		1.25
L3	0.51 BSC		
L4	0.60	0.80	1.00
L6	1.80 BSC		
θ1	5°	7°	9°
θ2	5°	7°	9°
V2	0°		8°

Figure 21. DPAK (TO-252) recommended footprint (dimensions are in mm)

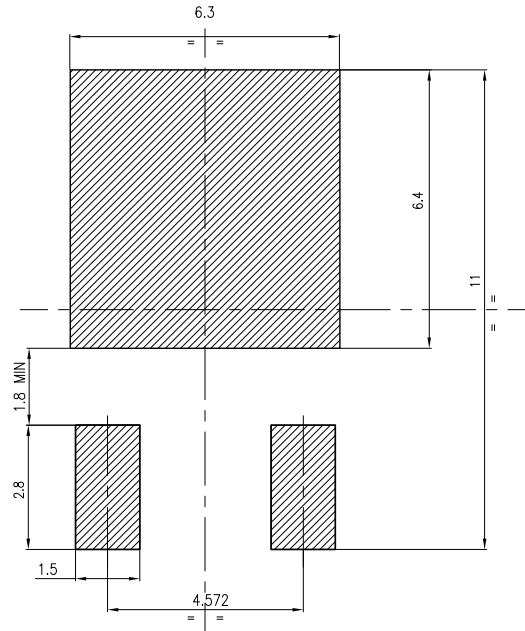

FP_0068772_25_C

4.3 DPAK (TO-252) packing information

Figure 22. DPAK (TO-252) tape outline

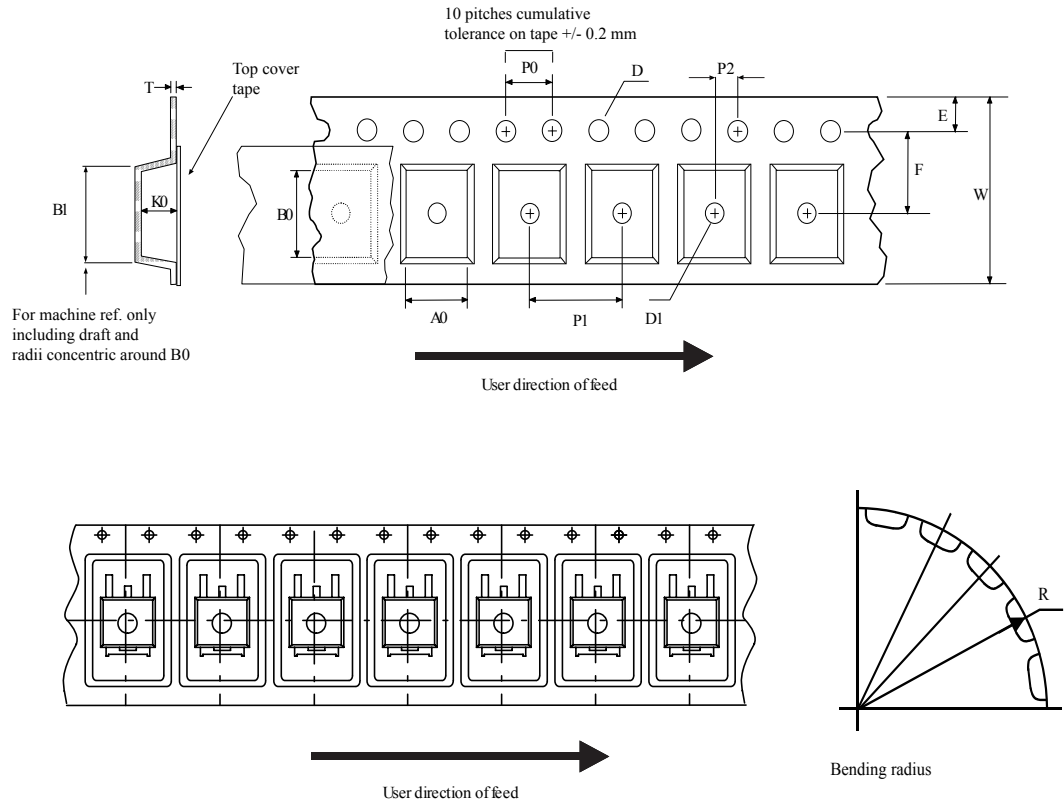

AM08852v1

Figure 23. DPAK (TO-252) reel outline

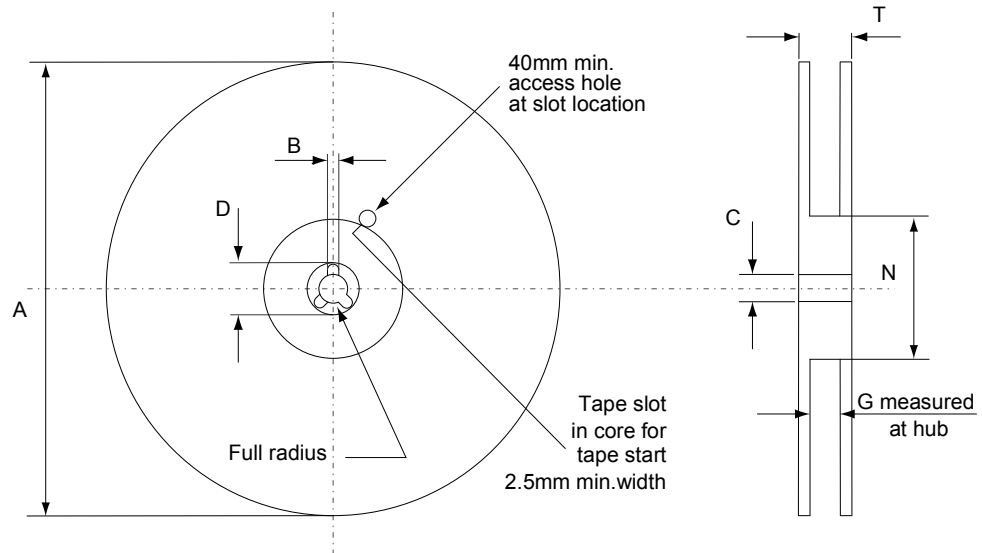

AM06038v1

Table 10. DPAK (TO-252) tape and reel mechanical data

Tape			Reel		
Dim.	mm		Dim.	mm	
	Min.	Max.		Min.	Max.
A0	6.8	7	A		330
B0	10.4	10.6	B	1.5	
B1		12.1	C	12.8	13.2
D	1.5	1.6	D	20.2	
D1	1.5		G	16.4	18.4
E	1.65	1.85	N	50	
F	7.4	7.6	T		22.4
K0	2.55	2.75			
P0	3.9	4.1	Base qty.		2500
P1	7.9	8.1	Bulk qty.		2500
P2	1.9	2.1			
R	40				
T	0.25	0.35			
W	15.7	16.3			

Revision history

Table 11. Document revision history

Date	Version	Changes
09-Jan-2014	1	First release.
18-Jun-2014	2	<ul style="list-style-type: none"> – Modified: title – Modified: values in <i>Table 4</i> – Modified: $R_{DS(on)}$ and I_{DSS} (test conditions) in <i>Table 5</i> – Modified: the entire typical values in <i>Table 6, 7 and 8</i> – Added: <i>Table 8</i> – Added: <i>Section 2.1: Electrical characteristics (curves)</i> – Updated: <i>Section 4: Package mechanical data</i> – Minor text changes
20-Aug-2018	3	<p>The document status is production data.</p> <p>Added Section 4.2 DPAK (TO-252) type C package information.</p> <p>Minor text changes.</p>

Contents

1	Electrical ratings	2
2	Electrical characteristics	3
2.1	Electrical characteristics curves	5
3	Test circuits	7
4	Package information	8
4.1	DPAK (TO-252) type A package information	8
4.2	DPAK (TO-252) type C package information	10
4.3	DPAK (TO-252) packing information	13
	Revision history	16

IMPORTANT NOTICE – PLEASE READ CAREFULLY

STMicroelectronics NV and its subsidiaries (“ST”) reserve the right to make changes, corrections, enhancements, modifications, and improvements to ST products and/or to this document at any time without notice. Purchasers should obtain the latest relevant information on ST products before placing orders. ST products are sold pursuant to ST’s terms and conditions of sale in place at the time of order acknowledgement.

Purchasers are solely responsible for the choice, selection, and use of ST products and ST assumes no liability for application assistance or the design of Purchasers’ products.

No license, express or implied, to any intellectual property right is granted by ST herein.

Resale of ST products with provisions different from the information set forth herein shall void any warranty granted by ST for such product.

ST and the ST logo are trademarks of ST. All other product or service names are the property of their respective owners.

Information in this document supersedes and replaces information previously supplied in any prior versions of this document.

© 2018 STMicroelectronics – All rights reserved